



25

YEAR ANNIVERSARY

Solutions Volume 18

- Labelling and Rotation ✓
- Temperature Control and Monitoring ✓
- Sanitation and Hygiene ✓
- Preventing Cross Contamination ✓
- Food Storage Solutions ✓
- Workplace Safety ✓

1800 673 644

sales@fildesfoodsafety.com.au
www.foodsafetysolutions.com.au



3-24

**Labelling
and Rotation**



25-35

**Temperature Control
and Monitoring**



36-41

**Sanitation
and Hygiene**



42-48

**Preventing Cross
Contamination**



49-57

**Food Storage
Solutions**



58-67

**Workplace
Safety**



What is FIFO?

FIFO means “first in, first out”. When receiving or preparing food, it should be labelled with a Use First, Shelf Life, or Day-of-The-Week label. Foods that are received or prepared first, should be used first. Write on a use by date and place new foods behind older foods in storage, to ensure the older foods are used first. The date you write should be the use by (discard) date, not the preparation date.



FIFO Works

Using labels to identify food means rotating foods correctly is easy. The bright colours draw your eye’s attention and quickly impart a message. After using the colour-coded system for a while, employees will identify use by dates just by colour, making the day-of-the-week system fast and efficient. The integrity of foods is maintained because foods are properly rotated.



How does FIFO work?

FIFO principles can extend to other products as well. Day of the Week Portion Bags will alert staff to those pre-portioned items that need to be used first. FIFO squeeze bottles allow for top filling and bottom dispensing, meaning older product is used first. FIFO essentially ensures that the freshest foods are being prepared.





Labelling and Rotation



Labelling and rotating of food is vital in protecting against foodborne illnesses.

Labelling food consistently and correctly ensures that you are serving the freshest and safest food, as well as reducing costly waste. Employing the FIFO (first in, first out) stock rotation method is best practice, and should be supported with a labelling system.

Fildes Food Safety stock a large range of labels in a variety of adhesives which can be incorporated into your food safety plan.

If you have a specific requirement for your operation, we can also custom print labels to suit your requirements.

LABEL AND ADHESIVE GUIDE

REMOVABLE LABELS



Easy to Remove	Safe for Freezer	Moisture Resistance	Min. Application Temperature	Working Temperature Range
✓✓	✓✓	✓	-12°C	-12°C to 71°C

- Most popular adhesive
- Easy to apply and remove
- Remove before washing to avoid sticky label residue

PERMANENT LABELS



Easy to Remove	Safe for Freezer	Moisture Resistance	Min. Application Temperature	Working Temperature Range
	✓✓✓	✓	-3°C	-53°C to 71°C

- Ideal for packaging that will be discarded
- Permanent labels cannot be removed
- Apply to dry surfaces before wetting or freezing

DISSOLVABLE LABELS



Easy to Remove	Safe for Freezer	Moisture Resistance	Min. Application Temperature	Working Temperature Range
✓✓✓			-1°C	-40°C to 80°C

- Labels will dissolve once immersed in water of any temperature
- Biodegradable
- Labels not suitable for fridge or freezer applications

DURABLE LABELS



Easy to Remove	Safe for Freezer	Moisture Resistance	Min. Application Temperature	Working Temperature Range
✓✓✓	✓✓✓	✓✓✓	-5°C	-30°C to 60°C

- Water resistant
- Ideal for fridge & freezer use
- Easy to remove after washing
- Will not tear

START UP KIT



24mm Circle Label Kit and 40mm Use First Label will be supplied in the same adhesive of your choice. Only 1 Start Up Kit available per customer.

Kit Contains:

- 24mm Circle Label Kit
- 40mm Use First Label
- Removable 60 x 40mm Received On Label
- Economy Infrared Thermometer
- Economy Waterproof Flat Digital Thermometer
- Thermometer Probe Wipes (Box of 100)

Adhesive	Product Code	
Removable	#98000	
Permanent	#98001	
Dissolvable	#98002	
Durable	#98003	



19mm CIRCLES



Roll of 2000

Adhesive	Product Code		
Removable	#10100 - specify day		
Permanent	#11100 - specify day		
Dissolvable*	#12100 - specify day		

*Dissolvable labels in rolls of 1000
Kit includes 1 x roll of each day plus dispenser

19mm CIRCLES - USE BY END OF DAY

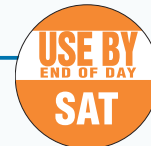

Roll of 2000

Adhesive	Product Code	Kit Code
Removable	#20100 - specify day	#20800

Kit includes 1 x roll of each day plus dispenser

24mm CIRCLES

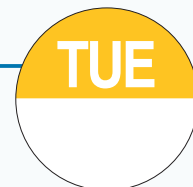

Roll of 1000

Adhesive	Product Code	Kit Code	
Removable	#80100 - specify day	#80800	
Permanent	#81100 - specify day	#81800	
Dissolvable	#82100 - specify day	#82800	
Durable	#83100 - specify day	#83800	

Kit includes 1 x roll of each day plus dispenser

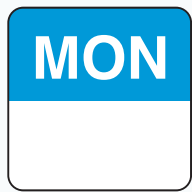
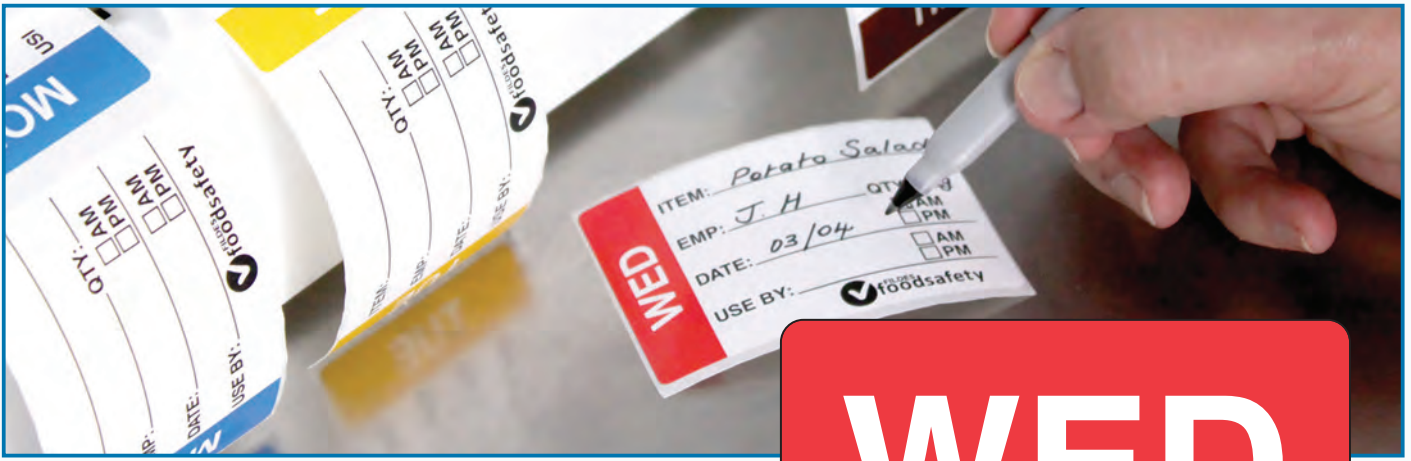

24mm

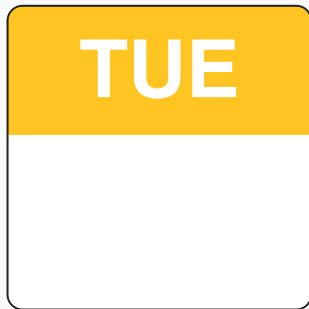

40mm



75mm

24mm SQUARE



Roll of 1000

Adhesive	Product Code	Kit Code	
Removable	#60100 - specify day	#60800	
Dissolvable	#62100 - specify day	#62800	

Kit includes 1 x roll of each day plus dispenser

40mm SQUARE



Roll of 500

Adhesive	Product Code	Kit Code	
Removable	#90100 - specify day	#90800	
Permanent	#91100 - specify day	#91800	
Dissolvable	#92100 - specify day	#92800	
Durable	#93100 - specify day	#93800	

Kit includes 1 x roll of each day plus dispenser

75mm SQUARE



Roll of 500

Adhesive	Product Code	Kit Code	
Removable	#50100 - specify day	#50800	

Kit includes 1 x roll of each day plus dispenser

40 x 50mm TRIANGLE

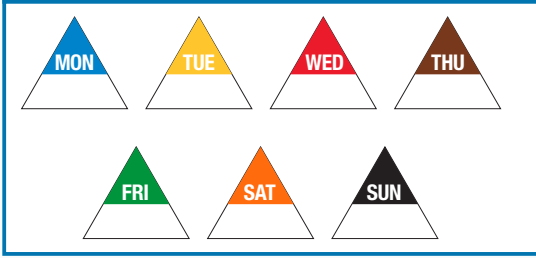

NEW!

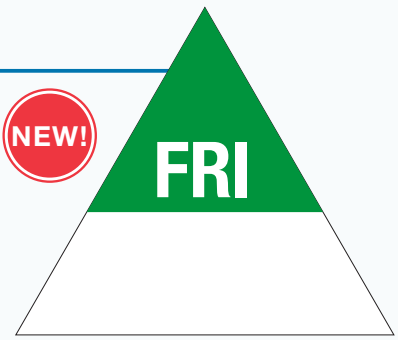

Roll of 1000

Adhesive	Product Code	Kit Code
Removable	#96500 - specify day	#96570

Kit includes 1 x roll of each day plus dispenser

49 x 75mm PREP



MON

ITEM: _____

EMP: _____ QTY: _____

AM

PM

DATE: _____

AM

PM

USE BY: _____



Roll of 250

Adhesive	Product Code	Kit Code
Removable	#30100 - specify day	#30800
Permanent	#31100 - specify day	#31800
Dissolvable	#32100 - specify day	#32800
Durable	#33100 - specify day	#33800

Kit includes 1 x roll of each day plus dispenser

38 x 25mm DATE / TIME



WED

ITEM	TIME <input type="checkbox"/> AM <input type="checkbox"/> PM
DATE	NAME

Roll of 500

Adhesive	Product Code	Kit Code
Removable	#40100 - specify day	#40800
Durable	#43100 - specify day	#43800

Kit includes 1 x roll of each day plus dispenser

HOW TO USE SHELF LIFE LABELS



Correctly identifying prepped food and the use by date is an essential part of the food rotation process.

Use a Shelf Life label to record important prep information, and combine with a Day of the Week coloured circle to clearly communicate to staff when the prepped item needs to be discarded.

47 x 99mm SHELF LIFE DAY OF THE WEEK

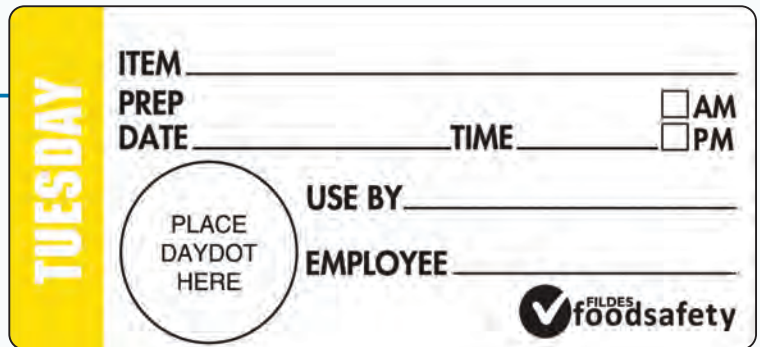

Roll of 500

Adhesive	Product Code	Kit Code
Durable	#15010 - specify day	#15080

Kit includes 1 x roll of each day plus dispenser

102 x 47mm SHELF LIFE

Roll of 500

Adhesive	Product Code
Removable	#77080
Permanent	#77180
Dissolvable	#77280
Durable	#77380

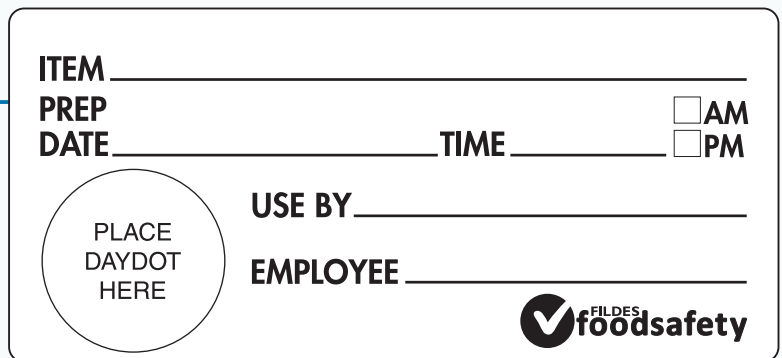

24mm SOLID COLOUR

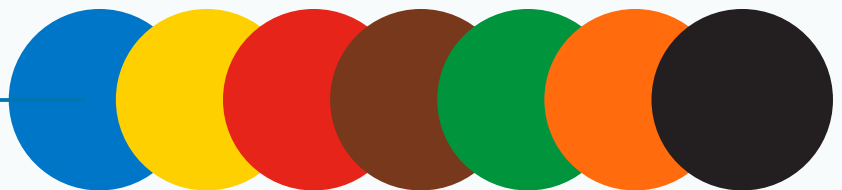

Roll of 1000

Adhesive	Product Code	Kit Code
Removable	#12010 - specify colour	#12080

Kit includes 1 x roll of each day plus dispenser

24mm RECEIVED ON

Roll of 1000

Adhesive	Product Code	
Removable	#14030	

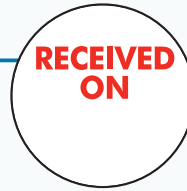

60 x 40mm RECEIVED ON

Roll of 500

Adhesive	Product Code	
Removable	#14090	



24 x 48mm RECEIVED ON / USE BY

Roll of 500

Adhesive	Product Code	
Removable	#14060	

Received: _____
Use By: ____/____/____

102 x 47mm RETURN TO VENDOR

Roll of 500

Adhesive	Product Code	
Removable	#11930	

 **DO NOT USE!**
RETURN TO VENDOR

DATE _____ REASON _____

19mm QA CHECKED

Roll of 1000

Adhesive	Product Code	
Removable	#14650	



102 x 47mm BLANK

Roll of 500

Adhesive	Product Code	
Removable	#99033	

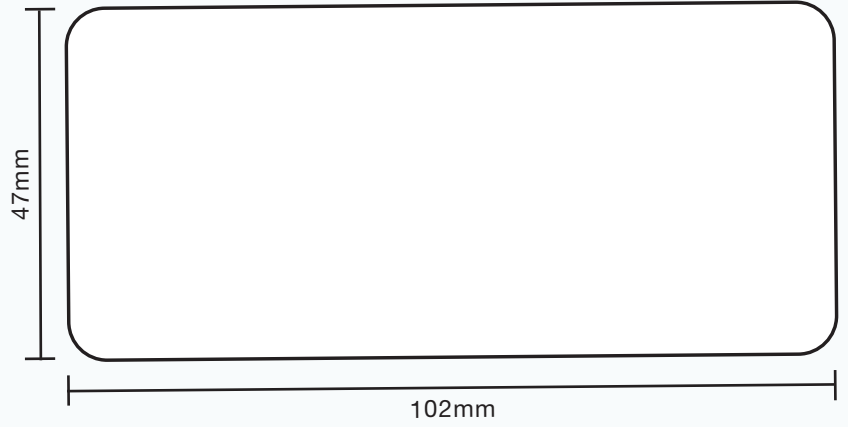

49 x 75mm BLANK

Roll of 500

Adhesive	Product Code	
Removable	#99032	

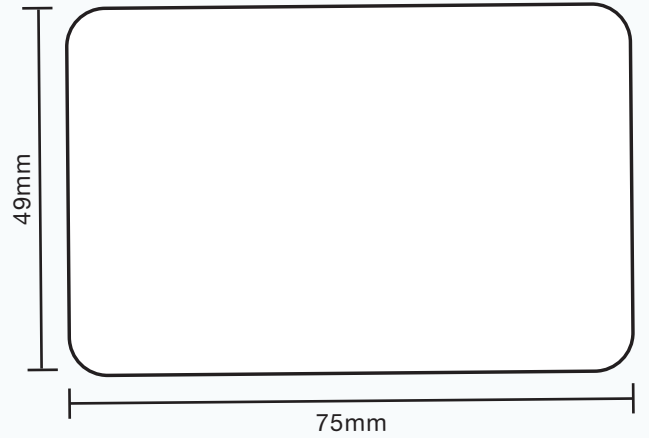

SQUARE BLANK

Roll of 1000

Adhesive	Product Code	
Removable	#99030 - 24mm	
Removable	#99031 - 40mm*	

*Roll of 500

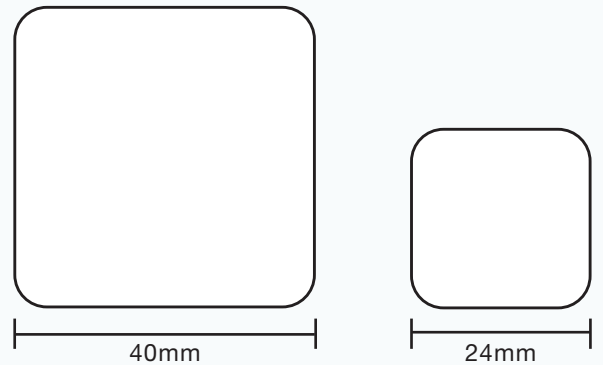

24mm CIRCLE BLANK

Roll of 1000

Adhesive	Product Code	
Removable	#12000	

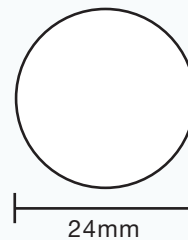

PERMANENT MARKERS

Product Code	Product	
#94010	Artline 700 - specify colour	
#94110	Sharpie Fine Point - specify colour	





FILDES FOOD SAFETY DISPENSERS

Fildes Food Safety label dispensers offer a convenient and hygienic method of housing your food safety labels.

- Made from sturdy, food grade plastic
- Can be wall mounted or free standing (mounting hardware and rubber feet included)
- Supplied as part of a labelling kit or can be purchased separately

24mm SEVEN ROLL DISPENSER

Product Code	
#19024	

Suitable for labels from 13mm to 24mm in size



51mm SEVEN ROLL DISPENSER

Product Code	
#19051	

Suitable for labels from 38mm to 50mm in size



75mm SEVEN ROLL DISPENSER

Product Code	
#19075	

Suitable for labels from 60mm to 75mm in size



CHOSEN THE WRONG LABEL IN THE PAST?



Residue from old labels can harbour dangerous bacteria. Take some time to evaluate your operation and determine which adhesive would best suit your practices.

Ambersil adhesive remover is suitable for removing self-adhesive labels from most surfaces. It is food processing safe, and will help to clean up your steam pans and storage containers.



49 x 75mm - BATCH NUMBER

Roll of 500

Adhesive	Product Code	
Removable	#14195	

PRODUCT _____

DATE _____

PREP. BY _____

BATCH NO. _____

49 x 75mm DATE DECANTED

Roll of 500

Adhesive	Product Code	
Removable	#14190	

ITEM: _____

DATE DECANTED: _____

USE BY: _____

EMPLOYEE: _____

49 x 75mm - DATE IN / OUT

Roll of 500

Adhesive	Product Code	
Removable	#14200	

PRODUCT _____

DATE IN _____

DATE OUT _____

TIME _____ AM PM

EMPLOYEE _____

49 x 75mm DATE / PREPARED / USE BY

Roll of 500

Adhesive	Product Code	
Removable	#78200 - Blue	
Dissolvable*	#78000 - Red	

DATE _____ / _____ / _____

PREPARED _____ AM PM

USE BY _____ AM PM

*Dissolvable labels in rolls of 250



38 x 25mm PRODUCT / DATE / PREP BY

Roll of 500

Adhesive	Product Code	
Removable	#14130	

Product _____
 Date ____ / ____ / ____
 Prep by _____

24 x 48mm PRODUCT

Roll of 500

Adhesive	Product Code	
Removable	#14100 - Blue	
Dissolvable	#14000 - Red	
Durable	#14300 - Black	

Product _____
 Date _____ Use By _____
 Time _____ ^{AM} _{PM} Initials _____

60 x 40mm PRODUCT / PREPARED ON / USE BY

Roll of 500

Adhesive	Product Code	
Permanent	#14250	



PRODUCT: _____
 Prepared on: _____
 Use by Date: _____
 Sign: _____

49 x 75mm - PRODUCT

Roll of 500

Adhesive	Product Code	
Removable	#76080	
Dissolvable	#76280	
Durable	#76380	

PRODUCT _____
DATE _____
PREP. BY _____
MGR. _____



102 x 47mm DEFROST PREP

Roll of 500

Adhesive	Product Code	
Removable	#14210	

PRODUCT _____ QTY _____

DEFROST ON M TU W TH F SA SU AM

PM

TIME TO DEFROST _____

USE BY DATE _____ TIME _____

EMPLOYEE _____

17 x 51mm FROZEN ON / DEFROSTED ON

Roll of 500

Adhesive	Product Code	
Removable	#14105	

FROZEN ON: _____

DEFROSTED ON: _____

102 x 47mm FROZEN PREP

Roll of 500

Adhesive	Product Code	
Removable	#14110	

PRODUCT _____

DATE MADE _____

DATE FROZEN _____

USE BY DATE _____

DATE DEFROSTED _____

102 x 47mm MANUFACTURER USE BY

Roll of 500

Adhesive	Product Code	
Durable	#14700	

PRODUCT: _____

Manufacturer's UBD: _____

Date Frozen: _____

Date Removed from Freezer: _____

Use by Date: _____



76 x 59mm MANUFACTURER USE BY

Roll of 500

Adhesive	Product Code	
Removable	#14570	

PRODUCT: _____

MANUFACTURERS
USE BY/BEST BEFORE DATE: _____

BATCH NO: _____

DATE FROZEN: _____

SHELF LIFE AFTER TAKEN
OUT OF FREEZER: _____

DATE REMOVED
FROM FREEZER: _____

38 x 25mm OPENED ON / USE BY

Roll of 500

Adhesive	Product Code	
Removable	#14065	

OPENED ON ____ / ____ / ____

USE BY ____ / ____ / ____

38mm OPENED ON

Roll of 500

Adhesive	Product Code	
Removable	#14020	

OPENED ON

DATE: _____

_____ AM
_____ PM

24mm PREP CIRCLES

Removable | Roll of 1000

Product Code	Product	
#14010	Opened On	
#14040	Frozen On	
#14120	Defrosted On	

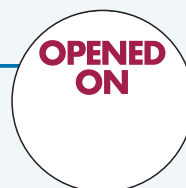



80mm USE BY

Roll of 500

Adhesive	Product Code	
Removable	#70600	

USE BY

40mm USE BY

Roll of 500

Adhesive	Product Code	
Removable	#70400	
Permanent	#71400	
Dissolvable	#72400	
Durable	#73400	

USE BY

24mm USE BY

Roll of 1000

Adhesive	Product Code	
Removable	#70200	
Permanent	#71200	
Dissolvable	#72200	

USE BY



80mm USE FIRST

Roll of 500

Adhesive	Product Code	
Removable	#70500	
Permanent	#71500	



40mm USE FIRST

Roll of 500

Adhesive	Product Code	
Removable	#70300	
Permanent	#71300	
Dissolvable	#72300	
Durable	#73300	



24mm USE FIRST

Roll of 1000

Adhesive	Product Code	
Removable	#70100	
Permanent	#71100	





SINGLE LINE DATING GUN

27JUN21



Product Code	Product	
#56000	SL Dating Gun	
#56003	Ink Rollers - 5 pack	

- Features 7 bands
- Month is printed in letters
- Simple to load and operate
- Ink roller included
- Please call customer service or visit our website for band layout

SINGLE LINE LABEL GUN

A\$55.12^{EA}



Product Code	Product	
#56001	SL Label Gun	
#56004	Ink Rollers - 5 pack	

- Features 8 bands
- Great for printing prices, dates, serial numbers and time
- Ink roller included
- Please call customer service or visit our website for band layout

SINGLE LINE LABEL GUN KIT

USE BY



Product Code	Product	Price
#56006	SL Label Gun Kit	\$125.00

- Kit contains:
- Single Line Label Gun
 - Pack of 5 ink rollers to suit
 - 10 roll pack of Removable Single Line Use By Gun labels

DOUBLE LINE LABEL GUN

ASASO50589
MAY 123456789



Product Code	Product	
#56002	DL Label Gun	
#56005	Ink Rollers - 5 pack	

- Features 10 bands
- Prints 2 lines per label
- Great for printing prices, dates, serial numbers and time
- Ink roller included
- Please call customer service or visit our website for band layout

21 x 12mm SINGLE LINE GUN LABELS

Permanent | Roll of 1000

5 Pack

Product Code	Product	
#58005	White	
#54050	Use By	
#54150	Best Before	
#54250	Received On	
#54450	Prepared On	
#54550	Made On	

10 Pack

Product Code	Product	
#59000	White	
#55000	Use By	
#55100	Best Before	
#55200	Received On	
#55400	Prepared On	
#55500	Made On	



Dissolvable | Roll of 1000

5 Pack

Product Code	Product	
#56685	White	
#56605	Use By	

10 Pack

Product Code	Product	
#56690	White	
#56610	Use By	

21 x 12mm SINGLE LINE DAY OF THE WEEK GUN LABELS

Permanent | Roll of 1000

Product Code	Product	
#56510	Day Of The Week - specify day - 5 pack	
#57010	Day Of The Week - specify day - 10 pack	

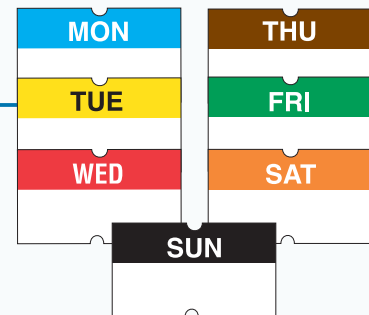

21 x 12mm SINGLE LINE - FLUORO GUN LABELS

Permanent | Roll of 1000

5 Pack

Product Code	Product	
#58025	Fluoro Yellow	
#58055	Fluoro Green	

10 Pack

Product Code	Product	
#59020	Fluoro Yellow	
#59050	Fluoro Green	

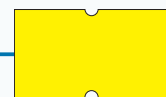

26 x 16mm DOUBLE LINE - GUN LABELS

Permanent | Roll of 1000

5 Pack

Product Code	Product	
#59115	White	
#59105	Use By	

10 Pack

Product Code	Product	
#59110	White	
#59106	Use By	





HEALTH AND AGED CARE



Labelling foods and liquids that have been modified is vital in ensuring that patients are not exposed to the risk of respiratory difficulties.

24mm THICKNESS LEVEL

Removable | Roll of 1000

Product Code	Product
#75250	Mildly Thick
#75260	Moderately Thick
#75270	Extremely Thick



24mm FOOD TEXTURE

Removable | Roll of 1000

Product Code	Product
#75280	Smooth Puree
#75290	Soft
#75300	Minced & Moist

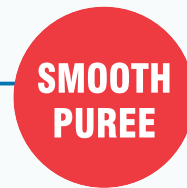

102 x 47mm RESIDENT

Removable | Roll of 500

Product Code
#11080

NAME	ROOM/BED No.
DATE RECEIVED	
RECEIVED FROM	
ITEM	
USE BY	

IDDSI LABELS



The International Dysphagia Diet Standardisation Initiative (IDDSI) introduced new labelling requirements in May 2019. These standards are designed to specifically assist workers in the healthcare system so they may easily classify and identify food and beverage consistencies which are suitable for patients with varying forms of dysphagia, a condition which involves difficulty swallowing.

Use these IDDSI compliant labels to provide the highest standard of patient care by greatly reducing the risk of serving incorrect meals to patients with dysphagia.

30mm TRIANGLE IDDSI DYSPHAGIA

Removable | Roll of 500

Product Code	Product
#75420	Thin
#75430	Slightly Thick
#75440	Mildly Thick
#75450	Moderately Thick
#75460	Extremely Thick
#75510	Liquidised
#75500	Pureed
#75490	Minced & Moist
#75480	Soft & Bite Sized
#75470	Regular
#75520	Easy To Chew

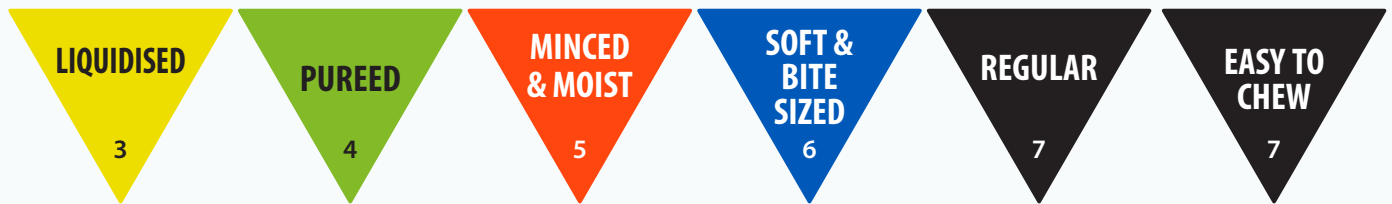
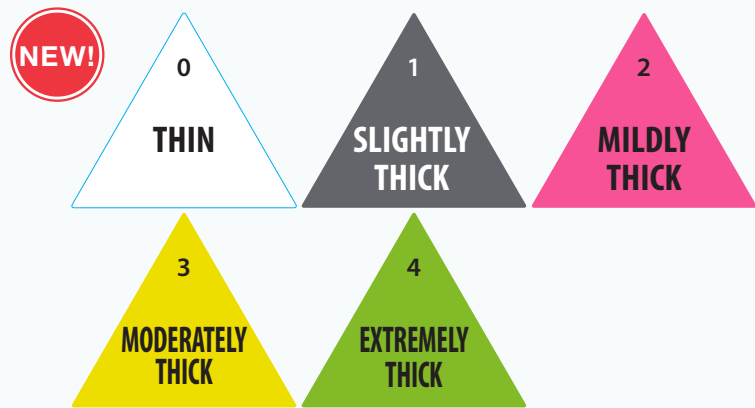

INSULATED PRODUCTS



Our healthcare range includes insulated products for efficient meal delivery. View these products in our Food Storage Solutions section on [page 50](#).





24mm FOOD ADVISORY

Removable | Roll of 1000

Product Code	Product	
#75020	Contains Nuts	
#75090	Vegetarian	
#75100	Dairy Free	
#75110	Gluten Free	
#75190	Diabetic	
#75200	Halal	
#75210	Vitamised	
#75220	Lactose Free	
#75240	Vegan	
#75360	Allergy	
#75370	Allergen	
#75380	Allergies	

40mm ALLERGY ADVISORY

Removable | Roll of 500

Product Code	Product	
#75040	Allergen - Red	
#75340	Allergy - Purple	



This Food May Contain

- Milk
- Tree Nuts
- Wheat
- Eggs
- Fish
- Lupin
- Sesame Seeds
- Shellfish
- Peanuts
- Soy
- Gluten

This Food Was Prepared With Your Allergy In Mind

- Gluten Free
- Dairy Free
- Egg Free
- Seafood Free
- Peanut Free
- Vegetarian
- Other

40mm CHILDCARE ALLERGY

Removable | Roll of 500

Product Code	
#75530	



60 x 40mm HOT ONLY / COLD ONLY

Permanent | Roll of 500

Product Code	Product	
#10920	Hot Only	
#10930	Cold Only	

Serving Safe **COLD** Take-Out Foods

Refrigerate within 1 hour of pick-up or purchase. Keep refrigerated at 4°C or below. Use within 7 days for prepared foods.

Serving Safe

HOT Take-Out Foods

Consume promptly or refrigerate within 1 hour of purchase. Keep refrigerated at 4°C or below. Reheat quickly to internal temperature of 60°C or above.

75mm HOT / COLD

Permanent | Roll of 500

Product Code	
#10910	

Serving Safe

HOT Take-Out Foods

Consume promptly or refrigerate within 1 hour of purchase. Keep refrigerated at 4°C or below. Reheat quickly to internal temperature of 60°C or above.

40mm DISCARD WITHIN 4 HOURS

Removable | Roll of 500

Product Code	
#10940	

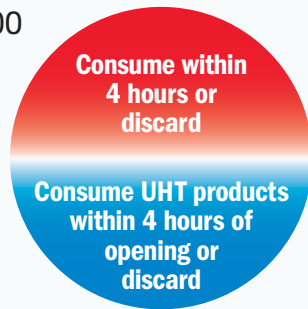

Serving Safe
COLD Take-Out Foods
Refrigerate within 1 hour of pick-up or purchase. Keep refrigerated at 4°C or below. Use within 7 days for prepared foods.

102 x 47mm TAMPER EVIDENT

Durable | Roll of 500

Product Code	
#10970	



80mm TAMPER EVIDENT

Durable | Roll of 500

Product Code	
#10960	

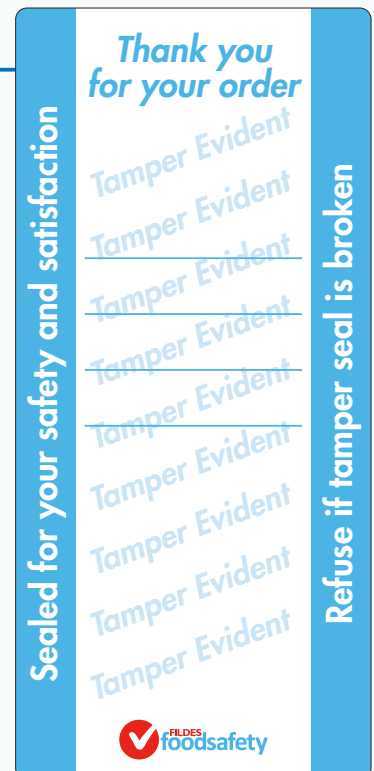



Temperature Control and Monitoring



Monitoring and controlling the temperature of food is a fundamental of food safety.

Using thermometers to ensure that foods are cooked to and maintained at correct temperatures is essential.

When foods are in the temperature danger zone of 5°C to 60°C for too long the food becomes highly susceptible to the rapid growth of bacteria.

Regular temperature monitoring is the best defence against bacteria. It must occur at every stage of the cooking, cooling, holding, and reheating process.

Fildes Food Safety offers a comprehensive range of thermometers and timers.



ECONOMY INFRARED THERMOMETER

- Temperature range: -50°C to 380°C
- Accuracy: ±1°C (b/w 0°C and 100°C)
- Display resolution: 0.1°C
- <1 second response time
- Belt mounted holder included
- Calibration certificate included
- Battery included: 9V
- 12 month warranty



Product Code	
#49601	

INFRARED THERMOMETER - BLUE

- Temperature range: -50°C to 380°C
- Accuracy: ±1°C (b/w 0°C and 100°C)
- Display resolution: 0.1°C
- <1 second response time
- LCD backlit display
- Battery power percentage display
- Emissivity adjustable
- Colour display
- Belt mounted holder included
- Calibration certificate included
- Battery included: 9V
- 12 month warranty



Product Code	
#49605	

HIGH TEMPERATURE RANGE INFRARED

- Temperature range: -50°C to 580°C
- Accuracy: ±1°C (b/w 0°C and 500°C)
- Distance spot ratio: 16:1
- Display Resolution: 0.1°C
- Auto off
- High/low temperature alarm setup
- Min/max/avg temperature measurement
- Twin laser pointer selection
- Data hold function
- Calibration certificate included
- Battery included: 9V
- 12 month warranty



Product Code	
#49602	

BODY / SURFACE TESTING THERMOMETER

Screen for signs of illness by using a non contact thermometer for instant and accurate temperature readings.

- Body temperature range: 32°C to 42.2°C
- Object temperature range: 10°C to 40°C
- Accuracy:
 - ±0.2°C body mode b/w 35°C to 42°C
 - ±0.3°C object mode
- Display: °C/°F
- Size: 166 x 39 x 40mm
- <1 second response time
- Screen display with fever alarm
- Body mode & object mode
- Built-in memory chip, 32 sets of memory storage
- Batteries included: AAA x 2
- 12 month warranty



Product Code	
#49630	

SLIMLINE INFRARED WITH PROBE THERMOMETER

The Slimline Infrared with Probe Thermometer features quick response light indicators. The indicators will show when temperatures are in the temperature danger zone, when foods are above the safe holding temperature of 60°C or more, or when chilled or frozen foods are in a safe temperature reading of 4°C or less.

- HACCP certified
- Infrared temperature range: -55°C to 250°C
- Infrared accuracy: $\pm 1^\circ\text{C}$
- Probe temperature range: -55°C to 330°C
- Probe length: 115mm
- Probe accuracy: 0.5°C
- Water resistant rating IP65
- Clip on pouch included
- Batteries included: AAA x 2
- 12 month warranty

Product Code	
#40606	



CALIBRATABLE DIGITAL THERMOMETER

- Temperature range: -50°C to 300°C
- Accuracy: $\pm 1^\circ\text{C}$
- Display resolution: 0.1°C
- Probe length: 125mm
- Water resistant rating IP65
- Field calibration function
- Min/max memory (b/w -19.9°C and 119.9°C)
- Automatic power shut off
- Low battery indication
- Convenient hanging hole and clip
- Calibration certificate included
- Battery included: CR2032
- 12 month warranty



Product Code	
#49310	

ALLERGEN SAFETY DIGITAL THERMOMETER

Allergens can inadvertently be transferred from a high risk food to an allergen free food by way of unsterilised utensils, hands and thermometers.

The Allergen Safety Digital Thermometer is colour coded purple to highlight that it is only to be used with allergen free foods.

- Temperature range: -50°C to 200°C
- Accuracy: $\pm 0.5^\circ\text{C}$ (b/w -10°C and 100°C)
- Display resolution: 0.1°C
- Probe length: 125mm
- Min/max temperature memory
- Data hold function
- Convenient hanging hole and clip
- Battery included: CR2032
- 12 month warranty

Product Code	
#49320	



DIGITAL PROBE THERMOMETER - USB RECHARGEABLE

- Temperature range: -50°C to 300°C
- Accuracy: $\pm 1^\circ\text{C}$
- Probe length: 102mm
- <3 second response time
- LCD display
- Waterproof rating IPX7
- Automatic power shut off after 30 seconds
- Battery included: 3.7V rechargeable lithium ion
- USB rechargeable (USB cable included)
- 12 month warranty



Product Code	
#40615	

WALL MOUNTABLE DIGITAL PROBE THERMOMETER

- Temperature range: -50°C to 200°C
- Accuracy: $\pm 1^\circ\text{C}$ (b/w -10°C and 200°C)
- Display resolution: 0.1°C
- Probe length: 115mm
- Water resistant IP67
- Auto off after 10 minutes
- Data hold function
- Min/max reading function
- Probe cover with pocket clip
- Hook for wall mounting
- Battery included: CR2032
- 12 month warranty



Product Code	
#49340	

ECONOMY WATERPROOF FLAT DIGITAL THERMOMETER

- Temperature range: -50°C to 200°C
- Accuracy: $\pm 1^\circ\text{C}$ (b/w -20°C and 119°C)
- Display resolution: 0.1°C
- Probe length: 120mm
- <1 second response time
- Water resistant rating IP65
- Probe cover can be used to extend the handle length
- Convenient hanging hole and clip
- Calibration certificate included
- Battery included: LR44
- 12 month warranty



Product Code	
#49306	

MINI DIGITAL PROBE THERMOMETER

- Temperature range: -50°C to 200°C
- Accuracy: $\pm 1^\circ\text{C}$ (b/w -10°C and 200°C)
- Display resolution: 0.1°C
- Probe length: 73mm
- Overall length of unit 155mm
- Water resistant IP67
- Auto off
- Data hold function
- Min/max reading function
- Calibration certificate included
- Battery included: CR2032
- 12 month warranty



Product Code	
#49312	

MULTIFUNCTION THERMOMETER

Dual thermometer probe sensor – meat and oven/BBQ.

- Tri-temperature jumbo LCD display
- Probe temperature range: 0°C to 200°C
- Oven/ambient temperature range: 0°C to 300°C
- Accuracy: $\pm 1^\circ\text{C}$ (b/w 0°C and 100°C)
 $\pm 2^\circ\text{C}$ (b/w 100°C and 200°C)
- Display resolution: 0.1°C
- Probe length: 150mm
- Retractable cord: 1000mm
- Alarm
- Unit cannot go in oven and is non-submersible
- Timer and estimated cooking time feature
- Calibration certificate included
- Battery included: AA
- 12 month warranty



Product Code	
#49216	

THERMOMETER PROBE WIPES

- Available in single use sachets, or convenient plastic pop-up dispenser
- Food safe and effective in killing 99.99% of all germs and bacteria
- Ingredients: alcohol, water, isopropyl alcohol

Product Code	
#40803 - Box of 100	
#40804 - Tub of 150	



LOLLIPOP MIN / MAX THERMOMETER

- Temperature range: -50°C to 200°C
- Accuracy: ±0.5°C (b/w -10°C and 100°C)
- Display resolution: 0.1°C
- Probe length: 125mm
- <1 second response time
- Min/max reading memory function
- Water resistant rating IP67
- Low battery indication
- Convenient hanging hole and clip
- Calibration certificate included
- Battery included: CR2032
- 12 month warranty

Product Code	
#40314	



HEAVY DUTY T-HANDLE THERMOMETER

T Shape design is easy to hold and insert, especially into solid foods.

- Temperature range: -50°C to 200°C
- Accuracy: ±0.5°C (b/w -10°C and 100°C)
- Display resolution: 0.1°C
- Probe length: 125mm
- <8 second response time
- Water resistant
- Min/max temp memory
- Automatic power shut off
- Data hold
- Convenient hanging hole and clip
- Calibration certificate included
- Battery included: LR44
- 12 month warranty

Product Code	
#49308	



HAND HELD DIGITAL THERMOMETER

Use to detect internal food and ambient temperatures.

- Probe temperature range: -50°C to 300°C
- Ambient temperature range: 0°C to 50°C
- Accuracy: ±0.5°C (b/w -19.9°C and 119.9°C)
±1°C (b/w 120°C and 149.9°C)
±2°C (for all other ranges)
- Display resolution: 0.1°C
- Probe length: 165mm
- Probe cord length: 1 metre
- <1 second response time
- Unit cannot go in oven and is non-submersible

- Min/max temperature memory
- Data hold function
- High/low alarm limit setting
- Replacement probes available
- °C/°F selection
- Low battery warning
- Protective PVC pouch and foldaway stand
- Calibration certificate included
- Batteries included: AA x 2
- 12 month warranty

Product Code	Product	
#49700	Thermometer	
#49750	Replacement Probe	



DIGITAL THERMOMETER WITH FOLDABLE PROBE

- Temperature range: -50°C to 300°C
- Accuracy: ±1°C
- Temperature resolution: .01°C/0.1F°
- Back light auto start up
- Automatic power shut off
- Data hold function
- °C/°F selection
- Min/max temperature measurement
- Battery included: LR44
- 12 month warranty

Product Code	
#40610	



ECONOMY POCKET DIAL THERMOMETER

- Temperature range: -10°C to 100°C
- Probe length: 127mm
- Dial face: 25mm
- Field calibration function
- Twisting wing nut at top of stem with fingers allows for easy re-calibration
- Stainless steel back
- Includes plastic stem case and metal pocket clip
- 12 month warranty



Product Code	
#49208	

CANDY / DEEP FRY THERMOMETER

- Temperature range: 38°C to 205°C
- Probe length: 125mm
- Dial face: 50mm
- Display: C°/F°
- Stainless steel body & probe
- Dishwasher safe
- Safety clip
- 12 month warranty



Product Code	
#40330	

MEAT DIAL THERMOMETER

- Zoned with specific HACCP parameters for popular meats
- Temperature range: 54°C to 88°C
- Probe length: 150mm
- Dial face: 64mm
- Heat-resistant glass cover allows the unit to go with food into the oven for easy temperature monitoring whilst cooking
- 12 month warranty



Product Code	
#40204	

DIGITAL COFFEE THERMOMETER



- Temperature range: 0°C to 200°C
- Probe length: 130mm
- Alarm sound with blinking alert
- LCD display
- Stainless steel probe & clip
- Batteries included: L1154F x 2
- 12 month warranty



Product Code	
#49215	

DIAL COFFEE THERMOMETERS

- Temperature range: 0°C to 100°C
- Stainless steel probe
- Small probe length: 140mm Dial face: 30mm
- Large probe length: 180mm Dial face: 48mm
- Ideal milk temperature is clearly colour coded on the dial
- Safety clip
- 12 month warranty



Product Code	
#49201 - small	
#49202 - large	

FRIDGE / FREEZER ALARM THERMOMETER

Features a dual display showing fridge and freezer temperatures. Attaches to fridge magnetically or can be situated on desk/bench using flip stand in conjunction with the dual 1 metre probe cords.



- Temperature range: -40°C to 70°C
- Accuracy: ±1°C
- Display resolution: 1°C
- Probe cord length: 1 metre
- Buzzer alarm and light for quick identification of temperature drops or spikes
- Temperature reading updates every 10 seconds
- Programmable alarm allows temperature limits to be set
- Records a min/max temperature for each display
- Calibration certificate included
- Batteries included: AAA x 2
- 12 month warranty

Product Code	
#49300	

DIGITAL FRIDGE & FREEZER THERMOMETERS

- Temperature range:
Fridge thermometer: -10°C to 50°C
Freezer thermometer: -25°C to 50°C
- Accuracy: ±1°C
- Display resolution: 0.1°C
- Temperature updates every 10 seconds
- Water resistant rating IP65
- Display will shut off once fridge is closed to save power
- Out of safety zone alert
- Low battery warning
- Battery included: CR2032
- 12 month warranty



Product Code	Product	
#49299	Digital Fridge Thermometer - Black	
#49298	Digital Freezer Thermometer - White	

FRIDGE / FREEZER DIAL THERMOMETER

- Temperature range: -30°C to 30°C
- Strong stainless steel casing
- Sit on shelf, or hang from rack
- Optimal temperature ranges highlighted
- Dial face: 60mm
- 12 month warranty



Product Code	
#49211	

FRIDGE / FREEZER THERMOMETER

- Temperature range: -40°C to 20°C
- Suction caps and clips for mounting
- Easy to read face
- Large bold numbers
- Magnifying lens cover
- 12 month warranty



Product Code	
#49102	

ECONOMY DIGITAL FRIDGE / FREEZER THERMOMETER

- Temperature range: -50°C to 110°C
- Accuracy: ±1°C
- Display resolution: 0.1°C
- Sensor cable length: 1 metre
- LCD display
- Batteries included: LR44 x 2
- 12 month warranty



Product Code	
#49280	

DIGITAL TOUCHSCREEN HYGRO THERMOMETER

- Temperature range: -20°C to 70°C
- Temperature accuracy: $\pm 1^\circ\text{C}$
- Humidity range: 20% to 95% RH
- Humidity accuracy: $\pm 5\%$
- Min/Max on display for temperature and humidity
- Measuring cycle: 10 seconds
- LCD display is backlit by touching front of unit
- Fold out stand
- Magnetic
- Batteries included: AAA x 2
- 12 month warranty

NEW!



Product Code	
#49701	

DIGITAL HYGRO THERMOMETER

- Temperature range: Indoor -10°C to +50°C Outdoor -50°C to +70°C
- Humidity range: 10% to 99% RH
- Accuracy: $\pm 1^\circ\text{C}$
- Indoor/outdoor temperature display, indoor humidity display
- Large LCD display
- 12h/24h time display
- Display changes between time & date every 5 seconds
- Temperature unit $^\circ\text{C}/^\circ\text{F}$ changeable
- Everyday alarm function
- External cable with sensor: 2 metres
- Foldaway stand or wall mount
- Battery included: AAA
- 12 month warranty



Product Code	
#49702	

DIGITAL TIMER

- Large, clear display
- Timer has a countdown/up function switch located at back of unit
- Loud buzzer sound (75 decibels)
- Memory recall function
- Magnetic attachment or foldaway stand
- Battery included: AAA
- 12 month warranty

Product Code	
#49715	



DIGITAL 24HR TIMER / CLOCK

- 12/24 hour time format display
- Display size: 38mm x 13mm
- Maximum count up 24 hours
- Maximum count down 23hr 59min 59sec
- Count down setting memory
- Pocket clip
- Foldaway stand
- Magnetic attachment
- Battery included: LR44
- 12 month warranty

Product Code	
#49719	



PH METER - LAQUA TWIN

- Fully waterproof and dustproof
- Water resistant rating IP67
- Accuracy: 0.1pH
- Automatic calibration
- Temperature alarm
- Low battery alarm
- Measurement range: 0 to 14pH

- Resolution: 0.1pH
- Two point calibration
- Voltage measurement mode
- Carry case
- Buffer solutions included: 14ml of pH4 and pH7
- Auto off after 30 minutes
- Battery included: CR2032
- Warranty: Instrument - 2 years, Sensor - 6 months



Product Code	
#49706	

SPEAR PH METER - APERA

Ideal for measurement of solid or semi-solid foods such as salami, cheese, meat, fruits and bread.

- pH range: -1.00 to 15.00pH
- pH accuracy: ± 0.01 pH
- Temperature range: 0°C to 50°C
- Display resolution: ± 0.01 pH and ± 0.1 °C
- Push button 3 point calibration
- Hold function
- Self-diagnostic to assist with troubleshooting
- Washable in mild detergent - not dishwasher safe
- Automatic power shut off
- Replacement sensors available on request
- Batteries included: AAA x 4
- Warranty: Instrument - 2 years, Sensor - 6 months



Product Code	
#49707	

PH METER - APERA

Ideal for measurement of semi solid foods and liquids, such as fruit, custards and sauces.

- pH range: -2.00 to 16.00pH
- pH accuracy: ± 0.01 pH
- Temperature range: 0°C to 50°C
- Display resolution: ± 0.01 pH and ± 0.2 °C
- Dual 3 colour backlit LCD display
- Push button 3 point calibration
- Hold function
- Self-diagnostic to assist with troubleshooting
- Washable in mild detergent - not dishwasher safe
- Replacement sensors available on request
- Auto off after 8 minutes
- Batteries included: AAA x 4
- Warranty: Instrument - 2 years, Sensor - 6 months



Product Code	
#49705	

PH METER CALIBRATION SOLUTION

- Essential for ensuring accurate readings are taken and recorded
- Each pH solution acts as a control point in calibration of the unit
- The Electrode Storage Solution is used for preventing dehydration of the glass electrode and helps lengthen lifespan

Product Code	Product	
#49709	pH Meter Calibration Kit	
#49708	pH Meter Electrode Storage Solution	
#49710	pH Meter Solution pH4	
#49711	pH Metere Solution pH7	



PH TEST STRIPS

- Monitor the pH of the product that you produce using paper pH strips
- pH paper test strips rely on colour change in the paper to indicate product pH
- Pack of 100 strips

Product Code	
#49712	



WHY USE DISHWASHER TEMPERATURE LABELS?

The temperature of the water used to wash utensils and cookware is critical to providing effective heat sanitising.

Dishwasher Temperature Labels will assist you in checking that your dishwasher is reaching effective sanitising temperatures and will demonstrate diligence in your food safety procedures.



DISHWASHER TEMPERATURE LABEL

Convenient and accurate method of measuring maximum thermal temperatures reached within a commercial dishwasher.

- Accuracy: $\pm 1^{\circ}\text{C}$
- Label withstands a full wash cycle and then can be transferred to your permanent records
- Great for HACCP recording measures
- Place on a metal object such as a stainless steel pan

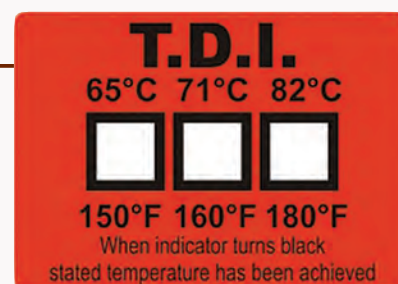

Product Code	Product	
#44010	Pack of 25	
#44020	Pack of 50	
#44030	Roll of 1000	

DISHTEMP DISHWASHER THERMOMETER

DishTemp thermometer simulates a plate as it's cleaned and sanitised in a commercial dishwasher, accurately recording the maximum surface temperature at the touch of a single button.



- Temperature range: 0 to 90°C
- Accuracy: $\pm 0.5^{\circ}\text{C}$
- Resolution: 0.1°C/°F
- Waterproof to IP66
- LCD display
- Weight: 120 grams
- Dimensions: 14 x 127mm
- Battery included: 3V CR2032 lithium coin cell
- Battery life: 40 hours
- Calibration certificate included
- 12 month warranty



Product Code	
#49740	

DISHTEMP BLUETOOTH DISHWASHER THERMOMETER

DishTemp thermometer simulates a plate as it's cleaned and sanitised in a commercial dishwasher, accurately recording the maximum surface temperature at the touch of a single button.



Bluetooth model DishTemp transmits temperature data to your iOS, Android or Bluetooth wireless device via a secure connection of up to 50 metres. Specifically designed to save time, paper and eliminate human error when recording temperature cycles.

Download HACCP LE from the Apple App store or Google Play Store.

- Records maximum surface temperature
- Temperature range: 0 to 90°C
- Accuracy: ±0.5°C
- Resolution: 0.1°C/°F
- Waterproof to IP66
- LCD display
- Weight: 120 grams
- Dimensions: 14 x 127mm
- Battery included: 3V CR2032 lithium coin cell
- Battery life: 40 hours
- Calibration certificate included
- 12 month warranty

Product Code	
#49745	

DATA LOGGERS



- Great for monitoring temperature sensitive products in both short haul and long-distance transportation applications
- Cold chain applications
- Refrigeration and transportation temperature monitoring
- Delayed start function
- Sampling interval
- Number of readings
- Continuous or fixed number of readings
- Configuration of conditions to activate the ALERT indicator

Put log tag in refrigerator, freezer, or transportation compartment



Transfer log tag to cradle and connect via USB cable



Product Code	Product	
#45000	LogTag - Ambient Temperature Logger (Multi use)	
#45010	LogTag - Analyser Software	
#45020	LogTag - USB Interface Cradle	
#45030	LogTag - for External Temperature Sensor (to be used with #45040)	
#45040	LogTag - S/Steel Probe (No Handle) (to be used with #45030)	
#45045	Logtag USB data logger	

Detailed and accurate reporting and charting of temperatures



COMFORT FLOW ANTI FATIGUE MAT

- Ideal for wet, dry or greasy environments
- Provides excellent anti fatigue properties for added employee comfort
- Superior resistance to grease and oil
- Anti-microbial treated to guard against odours and degradation
- Low profile edges and slip resistant surface reduces slip and fall accidents
- Non skid backing keeps the mat in place
- Light for easy handling and fully launderable
- Certified slip resistant by the National Floor Safety Institute
- 2 year warranty



NEW!

Product Code	Product	
#68000	580 x 860 x 11mm	

COMFORT SCRAPE ANTI FATIGUE MAT

- Use in wet and greasy, or dry environments
- Provides maximum resistance to oil, grease, animal fat and chemicals
- Superior anti fatigue properties to ensure employee comfort and ergonomic benefits
- Low profile and slip resistant surface helps minimise slip and fall accidents
- Easy to clean, simply hose off or pressure wash to remove debris
- Certified slip resistant by the National Floor Safety Institute
- 2 year warranty



NEW!

Product Code	Product	
#68005	840 x 1410 x 11mm	
#68010	840 x 2700 x 11mm	
#68015	1100 x 1700 x 11mm	

COMFYSAFE MAT - TERRACOTTA

- For use in wet and dry non greasy environments
- Highly versatile medium duty anti slip and anti fatigue with built in ramps
- Provides insulation from cold and heat off floors
- Good slip resistance
- 3 year warranty



NEW!

Product Code	Product	
#68030	900 x 1500 x 12mm	

COMFYSAFE PREMIUM MAT - BLACK

- For use in wet and dry non greasy environments
- Highly versatile medium duty anti slip and anti fatigue with built in ramps
- Provides insulation from cold and heat off floors
- Natural black rubber
- 3 year warranty



NEW!

Product Code	Product	
#68020	600 x 900 x 12mm	
#68025	900 x 1500 x 12mm	

SANITISING FOOT BATH

Keep your hygienic areas free of contamination and germs.

Thousands of pliable rubber scrapers dislodge contaminants from footwear as the shoe soles are immersed in disinfectant solution.

Product Code	Product	
#68035	600 x 800 x 13mm - 3.8 litres - Black	
#68040	800 x 1000 x 47mm - 20.8 litres - Black	
#68045	800 x 1000 x 47mm - 20.8 litres - Black/yellow	

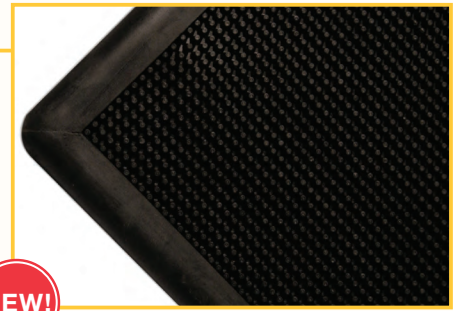

SUPERCOMFORT ANTI FATIGUE MAT

Unique, flexible suction cups act as supports for air cushions bringing together buoyancy and superb comfort.

- Excellent insulation against heat or cold off hard floors
- Raised dome design offers good slip resistance
- Suction cups underneath hold the mat firmly on the floor
- Low dome profile minimises collection of grime and dirt
- High density rubber compound prevents bacterial and fungal growth
- Easily cleaned with a mop
- 3 year warranty

Product Code	Product	
#68050	600 x 900 x 14mm - Black	
#68055	900 x 1200 x 14mm - Black	
#68060	900 x 1200 x 14mm - Black/yellow	

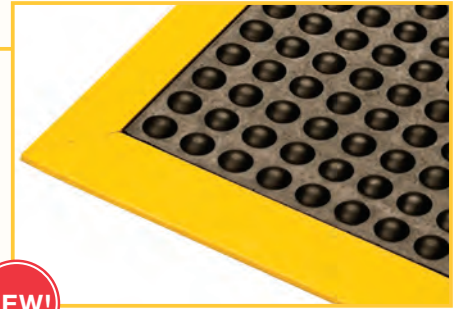

WATERHOG ENTRANCE MAT

Ideal entrance mat for all weather and high traffic conditions. For use inside or out.

- Raised rubber water dam traps dirt and absorbs water
- Rubber reinforced face nubs prevent pile from crushing
- Safety bevelled edges
- Certified slip resistant by the National Floor Safety Institute
- 3 year warranty

Product Code	Product	
#68065	600 x 900 x 10mm	
#68070	900 x 1500 x 10mm	
#68075	900 x 3000 x 10mm	
#68080	1200 x 1800 x 10mm	

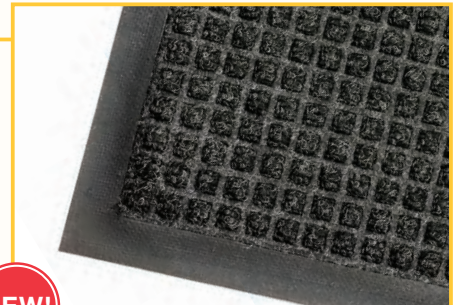

FRESH PRODUCE MATTING

Non-slip and tear resistant matting used to go under fruit and vegetable displays. This breathable mat has cushioning technology that prevents fruits and vegetables from bruising.

- Hardwearing and tear resistant material
- Durable PVC coated fabric, easy to clean and maintain
- Open construction allows great air circulation
- Can be cut to size

Product Code	Product	
#68085	900mm x 18m roll	

