

# Aussie Chef COLLECTION 2026



**AUSSIE**  **CHEF**  
CLOTHING COMPANY

# Welcome!

Explore the entire Aussie Chef Collection of aprons, chef jackets, pants, accessories, kids and footwear.

<b>Aprons</b>	<b>1</b>
Luca	2
Arlo	6
Luna	8
Tomy	10
Oska	12
Bella	14
Cantine	16
Barber	19
Mia Denim	20
Mia Utility Pouch	22
Leo Denim	23
Archie Denim	24
Hanna	26
Grey Combo	27
Axil Leather	28
Riley Leather	30
Heavyweight	32
Crossback	33
Monaco	34
Paris	35
London	36
Alex Chef Bib	37
Chef Bib	38
ProChef	40
Zoe PU	44
PVC & Nylon	46
Bistro	48
<b>Chef Jackets</b>	<b>50</b>
Arlo Chef Shirt	52
Alex Zipper	54
Alex Cool Mesh	57
Alex Press Stud	58
Alex Classic	60
Alex Classic Tee	61
Arli Shirt	62
Arli Prep Vest	64
Traditional	66
Modern Tunic	68
Lexi Jackets	70
<b>Chef Pants</b>	<b>72</b>
Alex Executive	74
Chef Pants	76
Lexi Pants	77
<b>Junior Chef</b>	<b>78</b>
Kids Aprons	80
Kids Jackets & Hats	81
<b>Chef Shoes</b>	<b>82</b>
Original Clogs	84
OKI Anti-Static Clogs	86
Classic Slip-On Clogs	89
MAXI Chef Sneakers	90
<b>Accessories</b>	<b>92</b>
Knife Wraps	93
Chef Hats	94
Apron Straps	96
Neckerchiefs & Buttons	97
<b>Branding</b>	<b>98</b>
<b>Size Guide</b>	<b>100</b>
<b>Stock Codes</b>	<b>102</b>
<b>About Us</b>	<b>106</b>





# APRONS

Luca



# Luca

## a game changer

Designed in fade-resistant, easy-care poly/cotton, our LUCA Apron is a step above. Elegant and smart, yet super durable - with leather look trim cross-back ties, towel loop & handy pockets. LUCA is an ideal chef apron or a gorgeous choice for front-of-house crews, busy baristas and talented bartenders.

Available in 7 stunning fade-resistant choices - black, bottle green, coffee, navy, rust, slate grey and stone - that keep looking great wash after wash.



# Luca

## mix-and-match

Ready when you are - colourfast LUCA Waist! Stands on its own or makes a great collab with LUCA Bib - both with handy towel loop and pockets. Perfect for those industries on the go - hospitality, beauty, florists, childcare + more.

Choose between 7 gorgeous fade-resistant colours - black, bottle green, coffee, navy, rust, slate grey and stone.



# Luca



Arlo



# Arlo

## built for work

Meet ARLO, designed to impress, it is the professional's choice in aprons. Crafted from a durable, fade-resistant heavyweight poly/cotton blend, ARLO is designed to stand up to the demands of busy cafes, bars, restaurants and much more - all while looking effortlessly stylish.

With a modern, functional design, ARLO aprons feature self-fabric adjustable neck straps and waist ties, a spacious utility pocket, and a clever towel loop within easy reach. Whether you're cooking, serving, brewing, baking, or styling - ARLO is the perfect choice - available in 7 stunning colours.



# Luna

## elevate your look

Designed in fade-resistant, easy-care poly/cotton, our LUNA Apron is elegant, yet hard-working - with leather look trim cross-back ties, towel loop & handy pockets. Long lasting, colourfast LUNA keeps looking great wash after wash.

Perfect for events or front-of-house staff, baristas, bartenders, florists, chefs - the list is endless. Choose between 6 gorgeous colours - slate grey, navy, bottle green, stone, black and coffee.



# Luna



Tomy





# Tomy

## edgy & tuff

TOMY Apron - built to last - in poly/cotton canvas weave. Created with leather-trimmed woven cross-back straps, and leather pen holder, the TOMY apron has grit. Strong and sturdy, cute and fun - pick your favourite! Available in 5 stunning colours - olive, coffee, black, cinnamon and blue.

Perfect for front-of-house crews, florist, bartenders, cafe baristas, talented chefs + more.



# Oska

## Lift your game

Aussie Chef OSKA bib aprons are beautifully crafted in soft, brushed heavyweight cotton to be durable and hard-wearing. A great choice for front-of-house staff, baristas, bakers, florists, schools + more. OSKA aprons are the perfect canvas for branding with embroidery or digital printing.

Pick between 8 gorgeous colours - tobacco, bottle green, navy, slate, olive, peach, mint & strawberry.

# Oska



# Bella

beautifully versatile

BELLA, short for 'bellissimo' or beautiful, has been a hit since first introduced. Lightweight yet hard-wearing, the BELLA bib apron is perfect for front-of-house, florists, beauty therapists + more.

Choose from 4 colour combinations - charcoal with ash straps, ash with charcoal straps, latte with blue straps and blue with latte straps. Or mix and match with 7 additional strap colours! A favourite for adding custom branding with embroidery or digital printing.



# Bella



# Cantine

## customer favourite

Aussie Chef CANTINE aprons combine elegance with functionality. CANTINE with its striking simplicity in 100% cotton canvas weave is the perfect choice for all occasions, casual or formal. It's easy to see why it is a customer favourite! The 100% cotton canvas weave fabric is designed to fade, adding character. Choose your favourite from 8 modern neutrals - khaki, navy, olive, black, stone, dark grey, chocolate, white. Also available in a waist apron in black or navy.



# Cantine



# Cantine





# Barber

## signature look

Designed in 100% cotton PU-coated fabric with a distressed leather look the BARBER is a stand-out. This hard-working apron with stunning metal details and an assortment of utility pockets is ready for any task. BARBER's unique look is ideal for skilled bartenders, talented baristas, in-demand barbers or to create a distinctive look for front-of-house staff.

Available in 3 metal-inspired colours - rust, pewter and bronze.

# Mia Denim





# Mia Denim

cute, short & sassy

A short denim apron - just what you asked for! MIA Denim, in lightweight 100% cotton denim, is ready to tackle any task. Perfect for those who adore DENIM! An easy, fun apron to wear - MIA is great for talented bakers, florists, front-of-house crews, baristas, artists, schools, hairdressers + more.

3 great choices - MIA with neck loop in black - MIA with cross-back straps in chambray or black - and cute MIA waist in chambray, black or navy. Make MIA Yours. Personalise it!



# Mia Utility Pouch

perfectly practical

A waiters friend, MIA Utility Pouch waist apron is cleverly compact, amazingly comfortable, with pockets for your every need. Simple to wear with a clip buckle adjustable waist band. Perfect when you need freedom of movement but want items close at hand.

Tough & functional Mia Utility Pouch is available in navy and black denim.

# Leo Denim

## an everyday hero

LEO Denim stands out with industrial jeans-style stitching in durable, lightweight 100% cotton denim. LEO is a fun, easy-to-wear apron for those on the go – great for front-of-house crews, baristas, bakers, chefs, bartenders, florists, artists, schools, hairdressers – or anyone who loves DENIM!

Choose your favourite LEO Denim - navy, black and chambray - or mix it up. Personalise LEO with your logo or names for even more impact.





# Archie Denim

## a crew favourite

ADD a POP of Colour with ARCHIE Denim aprons! Designed in a lightweight, dark indigo blue 100% cotton denim - with a choice of 9 different removable cross-back apron strap colours - coffee, red, tan, chocolate, grapefruit pink, sky blue, lemon yellow, lime green and tangerine orange.

The perfect apron for crews large or small - or anyone who loves DENIM!  
Make it STAND OUT by adding custom embroidery or printing.

# Archie Denim



# Hanna

## pinafore style

HANNA Pinafore made in natural linen, is stylish, lightweight, and soft to the touch. So comfortable to wear, with wide cross-back straps, two large patch pockets and a roomy, just-right fit. The one-piece construction means you just slip it over your head and arms, and it easily accommodates all body shapes. HANNA pinafore, also called a smock or Japanese-style apron is one size fits all. Perfect for creatives, chefs, bakers, florists, gardeners - the list is endless. Available in navy.





# Grey Combo

a pop of colour!

Add some eye-catching colour with GREY COMBO! These lightweight, grey 100% cotton bib aprons have a contrasting colour pocket and cross-back straps. Make it formal with an oxford shirt or chef jacket or go for a relaxed, casual look with a classic tee in white or black.

Choose from 3 different contrasting colour bib aprons – mocha, cherry or wine.



# Axil Leather

## luxurious yet practical

AXIL Leather designed in beautifully soft, 100% high-quality, grain cow leather with gorgeous metal rivets and buckle details, heavy-duty industrial stitching, and matching leather easy slip-on neck loop and waist ties. Leather aprons, worn for their protective and practical abilities, are a favourite with events staff, café baristas, trendy bartenders and in-demand barbers, or as a gift for a loved one.

Choose either gorgeous black or chocolate brown. AXIL is a perfect canvas for personalising!

# Axil Leather



# Riley Leather



# Riley Leather

## beautiful & protective

RILEY Leather is handmade in small batches making each apron naturally unique. Designed in soft, high-quality, grain leather with metal details and matching leather and woven cross-back straps. This soft leather apron becomes even more beautiful over time with each wear. Leather is heat resistant and protective, while exuding luxury. Perfect for events or FOH staff, baristas, bartenders + more.

Choose between gorgeous black or stunning brown. RILEY can easily be personalised - ask us how!



# Heavyweight

ready for any task

Our HEAVY WEIGHT bib apron in 240gsm black poly/cotton, is a simple yet professional choice. Designed with self-fabric adjustable neck loop and waist ties and a large pocket with pen insert - it is simplicity at its best. This easy-care, fade-resistant apron will keep looking fresh, wash after wash.

Make an impact by adding your branding with stunning embroidery or digital printing.

Aussie Chef offers a complete branding service to make it easy for you.





# Crossback

elegance at work

The Aussie Chef CROSS BACK apron in black is an understatement in style. This full apron with wide cross back straps in heavyweight, colourfast poly/cotton fabric, is the apron of choice for fine dining institutions. Paired with a crisp, white oxford, it exudes a professional elegance for front-of-house, waiters, events and catering staff. Perfect apron for branding. Available in black only.

# Monaco

## refined classic

Aussie Chef MONACO bib apron in black strikes the perfect professional look. Steps above a simple black apron with brushed silver eyelets at the neck and waist, for a touch of elegance. Designed in heavyweight, colourfast poly/cotton fabric, MONACO is durable, and easy to care for - retaining its colour and crispness. Wear it with a crisp white oxford, over a chef jacket or pair it with a classic tee.

Choose bib or waist in black - or create a look for your crew with a mix of both. Ideal to personalise!

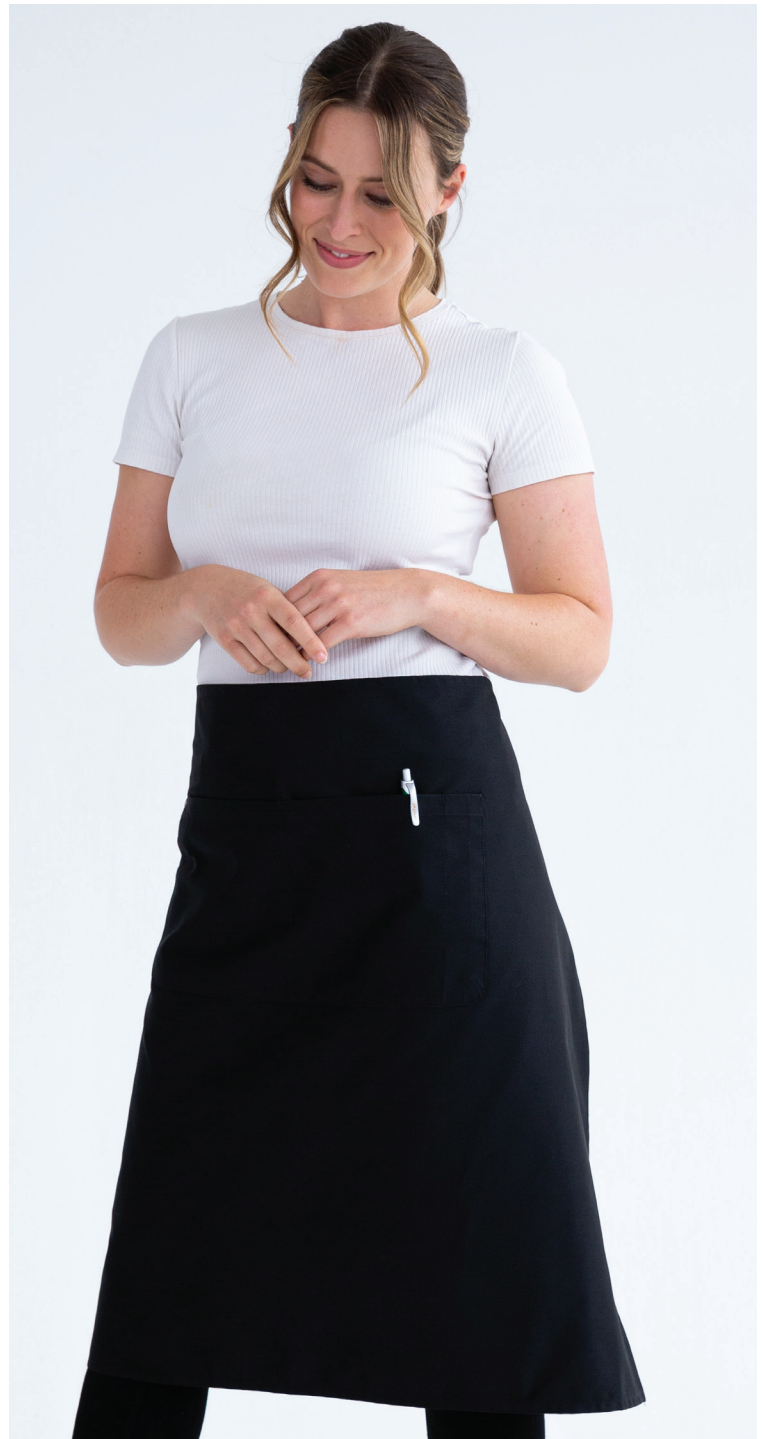



# Paris

## parisian pinstripe

PARIS is a true classic with its pinstriped fabric - reminiscent of cafes and restaurants in Paris, understated and classy. Designed with off-white neck loop and ties for subtle contrast, with pockets for your everyday essentials. PARIS will add flair to your bistro, restaurant, café, or bar.

Choose your favourite PARIS stripes - either black/white or navy/white. Made in colourfast, poly/cotton blend fabric, they are a gorgeous alternative to the traditional striped chef apron.

# London

## a chef's best friend

LONDON apron is a true worker, tough, sturdy and always reliable – it is the traditional striped bib apron chefs around the world choose time and time again. It is always on the best sellers list!

Traditional navy or black with thin white stripes, this colourfast, yarn-dyed poly/viscose blend fabric, takes the demands of busy kitchens in its stride. This classic LONDON bib apron pays homage to its namesake.





# Alex Chef Bib

ready in a snap

The ALEX Chef Bib apron is beautifully crafted with an easy-release buckle closure on the neck loop – for easy wear. Designed in the same lightweight poly/cotton that our ALEX Chef Jackets are made from, making it super durable & hard-wearing. A subtle, sophisticated choice that lifts your game, whether over the whole crew's chef uniforms or paired with a classic tee or oxford shirt for front-of-house staff. ALEX Chef bib is currently available in dark grey.

# Chef Bib

## timeless chef stripes

Chefs worldwide still gravitate towards classic stripes when choosing their aprons. Our Chef Bib aprons are super popular for that very reason. Designed in hard-wearing, colourfast poly/viscose fabric, these aprons are made to last, looking their best wash after wash. Chef Bib aprons are 86x86cm.

Chef Bibs are available in black or navy with thin white stripes - with or without a pocket.

Also available is the famed Butchers Bib apron in navy with wide vertical stripes.



# Chef Bib





# ProChef

## everyday basics

Simplicity for every day tasks. Black and white ProChef aprons are made to last. Designed in hard-wearing, durable, colourfast poly/cotton in three styles with and without a large pocket.

Full bib aprons are available in black, white or navy. The 3/4 waist aprons and 1/2 waist aprons come in black and white. Choose one or a combination for your team of professionals.

# ProChef bib



# ProChef 3/4 waist



ProChef 1/2 waist



ProChef navy



# ZOE

## waterproof & comfortable

Meet ZOE, a fashionable addition to our popular waterproof aprons range. Made from soft, durable, water-resistant PU. This apron is perfect for wet or messy environments - ideal for schools, kitchens, bakeries, studios + more. ZOE helps protect you from spills, splashes and sprays.

Lightweight & comfortable with its soft cloth backing, these aprons are a breeze to clean; simply wipe clean. ZOE's six colours will match any venue or school - black, bottle, burgundy, chocolate, grey and navy.



ZOE





# PVC & Nylon

## protective & waterproof

PVC and Nylon aprons are designed to keep you clean and dry in messy or wet environments. Popular with kitchen clean up crews, schools and more for their protective and waterproof features. Simple to keep clean and made to last.

Select PVC regular size in black, blue or white or PVC long aprons in either black or white. Our Nylon aprons come in either thin blue and white stripe or wide navy butchers stripe.

# PVC & Nylon



# Bistro

## durable simplicity

Bistro Chef Bib aprons are durable and hard-wearing in a simple, straightforward design, with a useful large pocket, neck loop and waist ties.

Strong and sturdy, these aprons allow for easy movement - while providing excellent protection. They are a great apron choice for chefs and kitchen staff, schools, bakers, front-of-house waiters & baristas – the list is endless. Bistro Chef aprons are available in multiple colours and stripes.



# Bistro



# CHEF JACKETS







# Arlo Chef Shirt

## built for service

Look and feel great in the versatile ARLO hospitality shirt designed to work as hard as you do. Durable enough for the kitchen, polished enough for the floor and comfortable from first coffee to final close. The ARLO Chef Shirt is thoughtfully tailored, offering all-day comfort and easy mobility. Smart design details - pearl press studs, classic shirt collar, tool pocket - make it a stand out choice. Available in white short sleeve in sizes XS-2XL. Level it up with an ARLO apron in 7 colour choices.

# Arlo Chef Shirt





# Alex Zipper

## zip up & GO!

Aussie Chef ALEX Zipper Chef Jacket is the ultimate in cool, a perfect unisex chef jacket for on-trend Chefs in the modern kitchen. Designed with the modern Chef in mind, with a more tailored fit, in super cool poly/cotton fabric with fine weave mesh side panels, a hidden zip front and an innovative zipper phone pocket. Arguably our most popular Chef Jacket!

Available in black and white in short or long sleeve. Grey and pink short sleeve only. Sizes XS-3XL.

# Alex Zipper



# Alex Zipper



# Alex Cool Mesh

keeps you COOL!

ALEX Cool Mesh Jacket, is designed to keep the modern Chef cool and collected, with fine weave mesh side panels and back yoke, allowing your skin to breathe. Alex Cool Mesh has a tailored fit with a traditional double-fronted button closure. Made in easy care, fade-resistant poly/cotton, it is part of our super popular Alex Chef Jacket range. Look good, feel great every day.

Alex Cool Mesh available in both black and white - sizes XS to 2XL.





# Alex Press Stud

## ready in a breeze

The ALEX Press Stud Jacket, was designed to be really easy and comfortable to wear. ALEX Press Stud, with its tailored fit, super cool poly/cotton fabric and simple press stud front closure, looks great on, while keeping you cool on your busiest day. Alex Press Stud is truly a best seller.

Available in black and white in short or long sleeve. Grey in short sleeve only. Sizes XS-3XL.

# Alex Press Stud



# Alex Classic

## modern tradition

ALEX Classic combines the tailored fit of ALEX with the traditional double-breasted button closure look many professional chefs are after. The ALEX Classic Jacket looks amazing, fits just right, is super comfortable to wear and keeps you cool and collected on your busiest days.

ALEX Classic is made from high-quality, fade-resistant poly/cotton fabric and is available in both black and white - sizes XS to 2XL.





# Alex Classic Tee

## basic essential

This super soft, 100% pre-shrunk cotton ALEX Classic Tee in white or black is a smart uniform choice. Wear it on its own, layer it with a favourite apron or wear it under a chef shirt. Made exclusively for Aussie Chef, these crew neck t-shirts have a modern regular, comfortable fit.

Personalise It. Make it Yours - these classic tees make a great canvas for embroidery or printing!  
Available in white or black - sizes XS to 2XL.



# Arli Shirt

easy zip up front

The Aussie Chef ARLI Shirt is the ultimate modern unisex shirt for chefs, waiters, front-of-house crews, hotel staff or even medical professionals. Looks great on its own or combined with an apron.

The ARLI Shirt is designed to make the life of staff easier! Tailored poly/cotton with a stand-up mandarin collar, pockets, back pleats and heavy-duty zip up front.

Choose between 5 fabulous colours - navy, latte, charcoal, white and black - sizes XS to 2XL.

# Arli Shirt



# Arli Prep Vest

## an industry first!

ARLI Chef Prep Vest - engineered to keep your chef jacket stain-free, clean, and fresh. A result of real-world insights and chef-driven innovation. This forward-thinking design revolutionises kitchen apparel in both functionality and aesthetics. Simply zip it up effortlessly over your uniform during prep time or during cooking, then take it off leaving your uniform impeccably clean underneath. Greet guests with confidence. Available in white - sizes XS to XL.



# Arli Prep Vest





# Traditional

## professional & timeless

Tried & true Traditional Jackets are still one of the most popular choices for chefs the world over. Double-breasted for the ultimate protection with traditional button closure in colourfast, poly/cotton. Today, chefs opt for white or black, long or short sleeve, according to their personal preference or as a whole team uniform. Traditional Jackets are also the go to for apprentice chefs at culinary schools.

Available in white and black, long and short sleeve - sizes XS to 4XL.

# Traditional



# Modern Tunic





# Modern Tunic

## simplicity & comfort

Modern Tunics balance professionalism with comfort. This minimalist, straight cut jacket, has a more generous fit with the ease of press studs, giving full protection with freedom to move in durable, colourfast poly/cotton. Chefs can choose their look in white or black, long or short sleeve, or create a uniform for the whole crew.

Choose between white and black, long and short sleeve - sizes S to 2XL.



# Lexi Jackets

## tailored excellence

Lexi Traditional Jackets are beautifully tailored for the perfect fit. Designed in colourfast, easy care, durable, poly/cotton with a double-breasted front and traditional buttons. The perfect balance of great looks and superior comfort.

Available in white and black, long and short sleeve in womens sizes - 8 to 16.

# Lexi Jackets



**CHEF PANTS**



# Alex Executive



# Alex Executive

## professional tailoring

Exclusive to Aussie Chef, ALEX Executive Pants with adjustable slide rail waistband are the ultimate chef pants. Designed for professional chefs, looking for smart, tailored pants. The adjustable waistband allows you to find just the right fit. ALEX Executive add a sophisticated look to your everyday workwear and are available in traditional black and white check or stunning black in unisex sizes XS - 2XL.



# Chef Pants

comfortable & durable

Complete your uniform with super comfortable, smart looking drawstring Chef Pants. Designed for easy wear with an elasticised, drawstring waist and useful front and back pockets. Made in soft yet durable, fade-resistant poly/cotton in traditional check or black.

Available in a wide range of unisex sizes - XS to 4XL - so you can find the perfect fit.





# Lexi Pants

## tailored ease

Finish off your uniform with tailored, elasticised, drawstring waist LEXI Chef Pants in traditional check or popular black. Designed to be comfortable, yet hard-wearing, with handy pockets - front and back. Made in fade-resistant poly/cotton, so they keep looking good wash after wash.

Tailored in womens sizes - 8 to 16.

# JUNIOR CHEF





# Junior Chef

## just for KIDS

Explore our KIDS Chef Clothing range made in kid-safe fabric. Perfect for KIDS who LOVE to dress the part - junior master chefs, beginner bakers, budding artists + more. Real chef jackets, aprons and chef hats made in KIDS sizes. Nurture their passions and foster their creativity.

KIDS aprons are super cute in pink, white, chambray or navy denim.

KIDS white chef jackets come in 4 sizes - 6/7, 8/9, 10/11, 12/13. Junior chef hats are also available.



# Junior Chef



# CHEF SHOES

all day every day







# Original Clogs

wear all day

Our Original Clogs are comfortable and soft, yet hard wearing. Their one piece construction made from innovative EVA material with a slip-resistant sole are functional, durable and protective.

Slip them on and off with ease. Work in comfort all day.

Choose from 3 styles - all **black**, **black** w/ red soles, or **white** w/ black soles.



slip-resistant | one-piece body construction | easy-care | slip on & slip off | sizes 36-45

# OKiCLOGS

anti-static technology





**anti-static | slip-resistant | shock-absorbing | water-proof | ultra-comfortable | easy-care**

OKI Slip-On Clogs are anti-static, super comfortable, lightweight, and flexible with anti-static and shock absorbing heel, making them easy to 'wear all day, every day'.

Choose your favourite - **pink** w/ blue soles, **navy** w/ black soles and **grey** w/ blue soles.

# OKiCLOGS

ultra-comfortable



# Slip-On Clogs

everyday basics



slip-resistant | one-piece body construction with back strap | waterproof | sizes 36-45



# MaXi

## Chef Sneakers

Introducing MAXI Chef Sneakers! The newest addition to our collection of super comfortable, lightweight, water-resistant, non-slip chef shoes. MAXI sneakers are athletic style shoes engineered to provide traction and support with specialised anti-slip soles with a circle-shaped pattern, grooved tread that adds extra grip across all types of surfaces, especially when slippery with oil or water.



water-resistant | slip-resistant | shock-absorbing | lightweight | super comfortable | sizes 36-45



# ACCESSORIES

# Knife Wraps

## a chef's essential

Knife Rolls and Wraps securely store your knives. Aussie Chef offers both leather and canvas weave nylon versions. Our exclusive Aussie Chef AXIL Leather 7 pocket Knife Rolls are luxurious yet practical, resilient to wear and tear - and come in gorgeous black or chocolate brown. Our tough canvas weave nylon Knife Wraps/Cases are durable and protective, and are available in 7, 10 or 14 pocket versions.



# Chef Hats

neat & tidy

Chef Hats not only complete your uniform, they also keep your hair out of the way and help to absorb sweat in the heat of the kitchen - keeping your work station clean and tidy.

Box Hats come in white, black, navy, as well as black or navy with white stripes. Our white Chef Hat has an adjustable velcro headband and our Disposable Paper Hats are one size fits all. Our black Baseball Caps are also super popular with chefs and front-of-house staff.



# Chef Hats



# Apron Straps

## mix & match

Just add COLOUR with removable, cross-back Apron Straps! Mix and match your favourite colour cross back ties with our beautiful BELLA and ARCHIE Denim aprons.

7 colours - leather-look chocolate or tan, grapefruit pink, lemon yellow, lime green, tangerine orange or sky blue.



# Neckerchiefs & Buttons

Add a finishing touch to your traditional chef uniform - with a Neckerchief in white.

Replacement buttons are a must for traditional button chef jackets - available in black and white.





# Brand It

## make it yours

Personalise your aprons and uniforms to stand out from the crowd! Our entire range of aprons, chef jackets, pants, t-shirts, hats and knife wraps can be personalised with custom embroidery or digital printing!

**Ask us HOW!**

# Brand It



# Size Guide

## find the right size

Measurements for chef jackets, chef pants and chef hats are based on the wearer's measurements and do not refer to the actual measurements of the garment. The garment will be larger than the body measurements in order to provide for a comfortable fit and easy movement.

Measurements for chef shoes/clogs is your foot length - our clogs use European sizing.

### Unisex

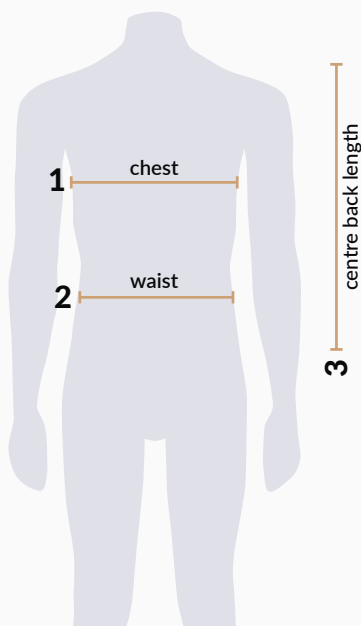

Measurements shown are the body measurements of the wearer not the garment.

#### CHEF JACKETS Traditional | Modern Tunic | Executive | Procool | StreetChef | New York | Classic

Unisex Sizes	XS	S	M	L	XL	2XL	3XL	4XL
<b>1</b> Chest (cm)	85	95	105	115	125	135	145	155

#### ALEX CLASSIC T-SHIRT

Unisex Sizes	XS	S	M	L	XL	2XL
<b>1</b> Chest (cm)	85	95	105	110	115	125
<b>3</b> Centre Back Length (cm)	64	66	68	70	72	73

#### ALEX & ARLI JACKETS Alex Classic | Alex Cool Mesh | Alex Press Stud | Alex Zipper | Arli Jacket

Unisex Sizes	XS	S	M	L	XL	2XL	3XL
<b>1</b> Chest (cm)	85	95	105	110	115	125	130

#### UNISEX PANTS Traditional Check | Black

Unisex Sizes	XS	S	M	L	XL	2XL	3XL	4XL
<b>2</b> Waist (cm)	46-70	56-80	66-90	76-100	86-110	96-120	106-130	116-140

#### EXECUTIVE PANTS Traditional Check | Black

Unisex Sizes	XS	S	M	L	XL	2XL
<b>2</b> Waist (cm)	65-75	70-80	75-85	80-90	85-95	90-100

### Womens

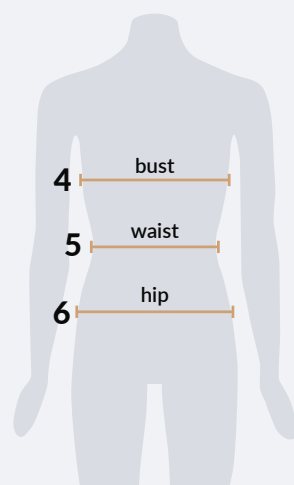

Measurements shown are the body measurements of the wearer not the garment.

#### WOMENS JACKETS

Womens Sizes	8	10	12	14	16
<b>3</b> Bust (cm)	92	97	102	107	112
<b>6</b> Hip (cm)	108	113	118	123	128

#### WOMENS PANTS Traditional Check | Black

Womens Sizes	8	10	12	14	16
<b>5</b> Waist (cm)	75	80	85	90	95

# Tips for taking your measurements

- Stand straight and relax
- Chest - measure the fullest part of your chest/bust with your arms down
- Waist - measure around your natural waistline above your hips
- Hips - measure around the fullest part of your hips

## Clogs & Chef Sneakers

### ATTENTION!

Measurement shown is your foot length

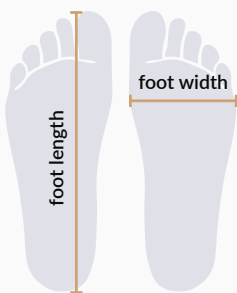

## ATTENTION!

Please check your foot measurement against the **Size Charts** below. Sizes may vary between styles.

- OKI Slip-On Clogs - Narrow Fit - NOT suitable for wide feet such as 3E and 4E fittings. -

OKI SLIP-ON CLOGS Pink   Grey   Navy								
Sizes	37 (US 5)	38 (US 6)	39 (US 6.5)	40 (US 7)	41 (US 8)	42 (US 9)	43 (US 10)	44 (US 10.5)
Foot Length (cm)	21.5	22.5	23	23.5	24.5	25	25.5	26.5
Foot Width (cm)	8	8.5	9	9.5	9.5	9.5	10	10

CLOGS Black   White   Black Slip-On											
Sizes	36 (US 5)	37 (US 5)	38 (US 6)	39 (US 6.5)	40 (US 7)	41 (US 8)	42 (US 9)	43 (US 10)	44 (US 10.5)	45 (US 11.5)	46 (US 12)
Foot Length (cm)	22.5	23	23.5	24	24.5	25	25.5	26	26.5	27	27.5

MAXI Chef Sneakers Black										
Sizes	36 (US 4.5)	37 (US 5)	38 (US 6)	39 (US 7)	40 (US 7.5)	41 (US 8)	42 (US 8.5)	43 (US 9)	44 (US 10.5)	45 (US 11.5)
Foot Length (cm)	22	22.5	23.5	24.5	25	25.5	26	26.5	27.5	29

## Box Hats

Measurements shown are the circumference of the wearers head

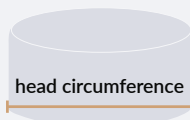

BOX HATS White | Black | Colours\*

Sizes	S	REG (M)	L
Head (cm)	50-54	53-57	56-60

\*Colours

Navy, Black Stripe, Navy Stripe, Black/White Check  
Available in REG (M) ONLY

## Kids

Chef Hat **7**

Chef Jacket **8** chest

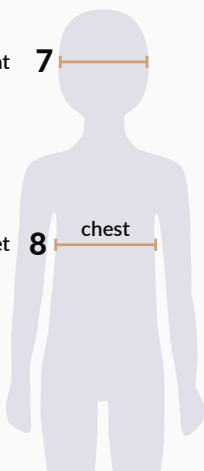

Measurements shown are the body measurements of the wearer not the garment.

JUNIOR Chef Hats

Kids Sizes	S	REG
7 Fits*	6-9yrs	10-13yrs

JUNIOR Jackets

Kids Sizes	6-7	8-9	10-11	12-13
8 Chest (cm)	68	74	78	82

\*Guide Only

Some children may not be of the standard size range.  
Please use your discretion in choosing your child's size.

## Junior Chef Bib

50 x 60cm

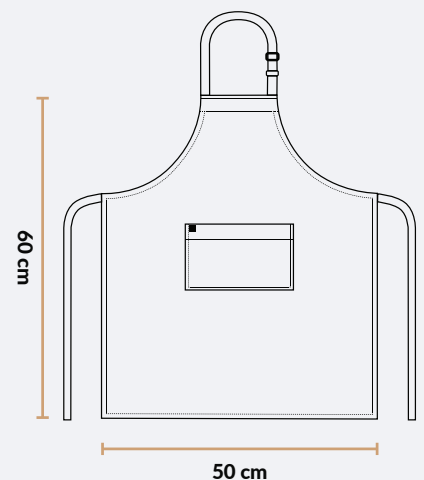

# Stock Codes

## APRONS

<b>P2-5</b>	<b>LUCA</b>	<b>Black</b>	<b>Navy</b>	<b>Bottle Green</b>	<b>Slate</b>	<b>Stone</b>	<b>Coffee</b>	<b>Rust</b>	<b>Black/Tan</b>
	Bib	AC-LUCA01	AC-LUCA02	AC-LUCA03	AC-LUCA04	AC-LUCA05	AC-LUCA06	AC-LUCA07	AC-LUCA21
	Waist	AC-LUCA10	AC-LUCA11	AC-LUCA12	AC-LUCA13	AC-LUCA14	AC-LUCA15	AC-LUCA16	
<b>P6-7</b>	<b>ARLO</b>	<b>Black</b>	<b>Navy</b>	<b>Bottle Green</b>	<b>Slate</b>	<b>Coffee</b>	<b>Rust</b>	<b>White</b>	
		AC-ARLO01	AC-ARLO02	AC-ARLO03	AC-ARLO04	AC-ARLO06	AC-ARLO07	AC-ARLO08	
<b>P8-9</b>	<b>LUNA</b>	<b>Black</b>	<b>Navy</b>	<b>Bottle Green</b>	<b>Slate</b>	<b>Stone</b>	<b>Coffee</b>		
		AC-LUNA01	AC-LUNA02	AC-LUNA03	AC-LUNA04	AC-LUNA05	AC-LUNA06		
<b>P10-11</b>	<b>TOMY</b>	<b>Blue</b>	<b>Olive</b>	<b>Black</b>	<b>Coffee</b>	<b>Cinnamon</b>			
		AC-TOMY01	AC-TOMY02	AC-TOMY03	AC-TOMY04	AC-TOMY05			
<b>P12-13</b>	<b>OSKA</b>	<b>Bottle Green</b>	<b>Slate</b>	<b>Tobacco</b>	<b>Olive</b>	<b>Navy</b>	<b>Mint</b>	<b>Peach</b>	<b>Strawberry</b>
		AC-OSKA01	AC-OSKA02	AC-OSKA03	AC-OSKA04	AC-OSKA05	AC-OSKA06	AC-OSKA07	AC-OSKA08
<b>P14-15</b>	<b>BELLA</b>	<b>Ash</b>	<b>Blue</b>	<b>Latte</b>	<b>Charcoal</b>	<b>(Other Colour Apron Straps available)</b>			
		AC-BELLA01	AC-BELLA02	AC-BELLA03	AC-BELLA04				
<b>P16-18</b>	<b>CANTINE</b>	<b>Khaki</b>	<b>Navy</b>	<b>Olive</b>	<b>Black</b>	<b>White</b>	<b>Chocolate</b>	<b>Dark Grey</b>	<b>Stone</b>
	Bib	PROECAN01	PROECAN02	PROECAN03	PROECAN04	PROECAN05	PROECAN10	PROECAN11	PROECAN12
	Waist		PROECAN07		PROECAN09				
<b>P19</b>	<b>BARBER</b>	<b>Bronze</b>	<b>Pewter</b>	<b>Rust</b>					
		AC-BARBER01	AC-BARBER02	AC-BARBER03					
<b>P20-21</b>	<b>MIA Denim</b>	<b>Black</b>	<b>Navy</b>	<b>Chambray</b>					
	Bib Neckloop	AC-MIA01							
	Bib Crossback	AC-MIA02		AC-MIA05					
	Waist	AC-MIA03	AC-MIA04	AC-MIA06					
<b>P22</b>	<b>MIA Utility Pouch</b>	<b>Black</b>	<b>Navy</b>						
		AC-POUCH05	AC-POUCH06						
<b>P23</b>	<b>LEO Denim</b>	<b>Black</b>	<b>Chambray</b>	<b>Navy</b>					
		AC-LEO01	AC-LEO02	AC-LEO03					
<b>P24-25</b>	<b>ARCHIE Denim</b>	<b>Coffee Ties</b>	<b>Red Ties</b>	<b>Other Colour Ties (Apron Straps sold separately P 90)</b>					
		AC-ARCHIE01	AC-ARCHIE02	AC-ARCHIE05					
<b>P26</b>	<b>HANNA</b>	<b>Navy</b>							
		AC-HANNA01							
<b>P27</b>	<b>GREY COMBO</b>	<b>Wine</b>	<b>Mocha</b>	<b>Cherry</b>					
		PROEGREY01	PROEGREY12	PROEGREY13					
<b>P28-29</b>	<b>AXIL Leather</b>	<b>Black</b>	<b>Brown</b>						
		AC-AXIL02	AC-AXIL04						
<b>P30-31</b>	<b>RILEY Leather</b>	<b>Black</b>	<b>Brown</b>						
		AC-RILEY02	AC-RILEY04						
<b>P32</b>	<b>HEAVY WEIGHT</b>	<b>Black</b>							
<b>P33</b>	<b>CROSSBACK</b>	AC-HWBBLK							
		<b>Black</b>							
		ACX001							
<b>P34</b>	<b>MONACO</b>	<b>Black</b>							
	Bib	PROEA10P							
	Waist	PROEA12P							

P35	PARIS	Black	Navy						
		PROECA02	PROECA03						
P36	LONDON	Black/White	Navy/White						
		10804	10810						
P37	ALEX Chef Bib	Grey							
		AC-ALEXCHEFBIB02							
P38-39	CHEF Bib	Butchers	Black/White	Black/White Pkt	Navy/White	Navy/White Pkt			
		10795-VER	10802	10802P	10807	10807P			
P40-43	PROCHEF Aprons	White	Black	Navy					
	Bib	PROA08	PROA15						
	Bib with pkt	PROA08P	PROA15P	PROA20P					
	3/4 Waist	PROA10	PROA17						
	3/4 Waist with pkt	PROA10P	PROA17P						
	1/2 Waist		PROA16						
	1/2 Waist with pkt		PROA16P						
P44-45	ZOE PU	Green	Burgundy	Chocolate	Grey	Navy			
		AC-ZOE01	AC-ZOE02	AC-ZOE03	AC-ZOE04	AC-ZOE05			
P46-47	PVC/NYLON	White	Black	Navy	Blue/White	Navy Butchers			
	Regular	10850	10851	10854	10865	10870			
			10873						
	Long	10860	10862						
P48-49	BISTRO - Solid	White	Black	Navy	Dark Green	Red	Navy	Brown	Black
	Colours	AC-10760P	AC-10770P	AC-10780P	AC-10817P	AC-10819P	AC-10820P	AC-10822P	AC-10825P
		Navy/White	Navy/White	White/Grey	Black/White	Navy/White	Chloe		
	Stripes	AC-10795-HOR	AC-10795-VER	AC-10904-VER	AC-ACMC200	AC-ACMC210	AC-CHLOE01		

## CHEF JACKETS

P52-54	ARLO Chef Shirt	XS	S	M	L	XL	2XL		
	White Short Sleeve	ACARLOS01	ACARLOS02	ACARLOS03	ACARLOS04	ACARLOS05	ACARLOS06		
P54-56	ALEX Zipper	XS	S	M	L	XL	2XL	3XL	
	White Short Sleeve	ACALEX01	ACALEX02	ACALEX03	ACALEX04	ACALEX05	ACALEX06	ACALEX07	
	White Long Sleeve	ACALEX01-LS	ACALEX02-LS	ACALEX03-LS	ACALEX04-LS	ACALEX05-LS	ACALEX06-LS	ACALEX07-LS	
	Black Short Sleeve	ACALEX11	ACALEX12	ACALEX13	ACALEX14	ACALEX15	ACALEX16	ACALEX16	
	Black Long Sleeve	ACALEX11-LS	ACALEX12-LS	ACALEX13-LS	ACALEX14-LS	ACALEX15-LS	ACALEX16-LS	ACALEX16-LS	
	Grey Short Sleeve	ACALEX80	ACALEX81	ACALEX82	ACALEX83	ACALEX84	ACALEX85		
	Pink Short Sleeve	ACALEXW01	ACALEXW02	ACALEXW03	ACALEXW04	ACALEXW05			
P57	ALEX Cool Mesh	XS	S	M	L	XL	2XL		
	White Short Sleeve	ACALEX40	ACALEX41	ACALEX42	ACALEX43	ACALEX44	ACALEX45		
	Black Short Sleeve	ACALEX50	ACALEX51	ACALEX52	ACALEX53	ACALEX54	ACALEX55		
P58-59	ALEX Press Stud	XS	S	M	L	XL	2XL	3XL	
	White Short Sleeve	ACALEX20	ACALEX21	ACALEX22	ACALEX23	ACALEX24	ACALEX25	ACALEX26	
	White Long Sleeve	ACALEX20-LS	ACALEX21-LS	ACALEX22-LS	ACALEX23-LS	ACALEX24-LS	ACALEX25-LS	ACALEX26-LS	
	Black Short Sleeve	ACALEX30	ACALEX31	ACALEX32	ACALEX33	ACALEX34	ACALEX35	ACALEX36	
	Black Long Sleeve	ACALEX30-LS	ACALEX31-LS	ACALEX32-LS	ACALEX33-LS	ACALEX34-LS	ACALEX35-LS	ACALEX36-LS	
	Grey Short Sleeve	ACALEX90	ACALEX91	ACALEX92	ACALEX93	ACALEX94	ACALEX95		
P60	ALEX Classic	XS	S	M	L	XL	2XL		
	White Short Sleeve	ACALEX1000	ACALEX1001	ACALEX1002	ACALEX1003	ACALEX1004	ACALEX1005		
	Black Short Sleeve	ACALEX1010	ACALEX1011	ACALEX1012	ACALEX1013	ACALEX1014	ACALEX1015		
P61	ALEX Classic Tee	XS	S	M	L	XL	2XL		
	Black	ACALEXT01	ACALEXT02	ACALEXT03	ACALEXT04	ACALEXT05	ACALEXT06		
	White	ACALEXT10	ACALEXT11	ACALEXT12	ACALEXT13	ACALEXT14	ACALEXT15		

## CHEF JACKETS

<b>P62-63</b>	<b>ARLI Shirt</b>	<b>S</b>	<b>M</b>	<b>L</b>	<b>XL</b>	<b>2XL</b>			
	White	ACARLI02	ACARLI03	ACARLI04	ACARLI05	ACARLI06			
	Charcoal	ACARLI11	ACARLI12	ACARLI13	ACARLI14	ACARLI15			
	Navy	ACARLI21	ACARLI22	ACARLI23	ACARLI24	ACARLI25			
	Latte	ACARLI31	ACARLI32	ACARLI33	ACARLI34	ACARLI35			
	Black	ACARLI41	ACARLI42	ACARLI43	ACARLI44	ACARLI45			
<b>P64-65</b>	<b>ARLI Prep Vest</b>	<b>XS</b>	<b>S</b>	<b>M</b>	<b>L</b>	<b>XL</b>			
		ACARLI50	ACARLI51	ACARLI52	ACARLI53	ACARLI54			
<b>P66-67</b>	<b>TRADITIONAL</b>	<b>XS</b>	<b>S</b>	<b>M</b>	<b>L</b>	<b>XL</b>	<b>2XL</b>	<b>3XL</b>	<b>4XL</b>
	White Long Sleeve	PROJ01	PROJ02	PROJ03	PROJ04	PROJ05	PROJ06	PROJ07	PROJ08
	White Short Sleeve	PROJ01-SS	PROJ02-SS	PROJ03-SS	PROJ04-SS	PROJ05-SS	PROJ06-SS	PROJ07-SS	PROJ08-SS
	Black Long Sleeve	PROJ15	PROJ16	PROJ17	PROJ18	PROJ19	PROJ20	PROJ21	PROJ22
	Black Short Sleeve	PROJ15-SS	PROJ16-SS	PROJ17-SS	PROJ18-SS	PROJ19-SS	PROJ20-SS	PROJ21-SS	PROJ22-SS
<b>P68-69</b>	<b>MODERN Tunic</b>	<b>S</b>	<b>M</b>	<b>L</b>	<b>XL</b>	<b>2XL</b>			
	White Long Sleeve	PROT02	PROT03	PROT04	PROT05				
	White Short Sleeve	PROT02-SS	PROT03-SS	PROT04-SS	PROT05-SS	PROT06-SS			
	Black Long Sleeve	PROT16	PROT17	PROT18	PROT19				
	Black Short Sleeve	PROT16-SS	PROT17-SS	PROT18-SS	PROT19-SS	PROT20-SS			
<b>P70-71</b>	<b>LEXI Jacket</b>	<b>8</b>	<b>10</b>	<b>12</b>	<b>14</b>	<b>16</b>			
	White Long Sleeve	PROLJ01	PROLJ02	PROLJ03	PROLJ04	PROLJ05			
	White Short Sleeve	PROLJ01-SS	PROLJ02-SS	PROLJ03-SS	PROLJ04-SS	PROLJ05-SS			
	Black Long Sleeve	PROLJ11	PROLJ12	PROLJ13	PROLJ14	PROLJ15			
	Black Short Sleeve	PROLJ11-SS	PROLJ12-SS	PROLJ13-SS	PROLJ14-SS	PROLJ15-SS			

## CHEF PANTS

<b>P74-75</b>	<b>ALEX Executive</b>	<b>XS</b>	<b>S</b>	<b>M</b>	<b>L</b>	<b>XL</b>	<b>2XL</b>		
	Traditional Check	ACALEXP01	ACALEXP02	ACALEXP03	ACALEXP04	ACALEXP05	ACALEXP06		
	Black	ACALEXP10	ACALEXP11	ACALEXP12	ACALEXP13	ACALEXP14	ACALEXP15		
<b>P76</b>	<b>Drawstring Pants</b>	<b>XS</b>	<b>S</b>	<b>M</b>	<b>L</b>	<b>XL</b>	<b>2XL</b>	<b>3XL</b>	<b>4XL</b>
	Traditional Check	PROPO1	PROPO2	PROPO3	PROPO4	PROPO5	PROPO6	PROPO7	PROPO8
	Black	PROPO15	PROPO16	PROPO17	PROPO18	PROPO19	PROPO20	PROPO21	PROPO22
<b>P77</b>	<b>LEXI Pants</b>	<b>8</b>	<b>10</b>	<b>12</b>	<b>14</b>	<b>16</b>			
	Traditional Check	PROWP01	PROWP02	PROWP03	PROWP04	PROWP05			
	Black	PROWP11	PROWP12	PROWP13	PROWP14	PROWP15			

## JUNIOR CHEF

<b>P80</b>	<b>Junior Chef Aprons</b>	<b>White</b>	<b>Chambray</b>	<b>Navy</b>	
		AC-JUNIORCHEF20	AC-JUNIORCHEF21	AC-JUNIORCHEF22	
<b>P81</b>	<b>Junior Chef Jackets</b>	<b>6-7</b>	<b>8-9</b>	<b>10-11</b>	<b>12-13</b>
		AC-JUNIORCHEF01	AC-JUNIORCHEF02	AC-JUNIORCHEF03	AC-JUNIORCHEF04
<b>P81</b>	<b>Junior Chef Hats</b>	<b>Small</b>	<b>Regular</b>	<b>Disposable</b>	
		AC-JUNIORCHEF30	AC-JUNIORCHEF31	AC-JUNIORCHEF32	

## CLOGS

<b>P84-85</b>	<b>CLOGS</b>	<b>36</b>	<b>37</b>	<b>38</b>	<b>39</b>	<b>40</b>	<b>41</b>	<b>42</b>	<b>43</b>	<b>44</b>	<b>45</b>
	White	ACCLOG136	ACCLOG137	ACCLOG138	ACCLOG139	ACCLOG140	ACCLOG141	ACCLOG142	ACCLOG143	ACCLOG144	ACCLOG145
	Black with Red Sole	ACCLOG36	ACCLOG37	ACCLOG38	ACCLOG39	ACCLOG40	ACCLOG41	ACCLOG42	ACCLOG43	ACCLOG44	ACCLOG45
	Black	PROCLOG36	PROCLOG37	PROCLOG38	PROCLOG39	PROCLOG40	PROCLOG41	PROCLOG42	PROCLOG43	PROCLOG44	PROCLOG45
<b>P86-88</b>	<b>OKI CLOGS</b>	<b>36/37</b>	<b>38</b>	<b>39</b>	<b>40</b>	<b>41</b>	<b>42</b>	<b>43</b>	<b>44</b>	<b>45</b>	
	Grey-Blue	ACCLOG337	ACCLOG338	ACCLOG339	ACCLOG340	ACCLOG341	ACCLOG342	ACCLOG343	ACCLOG344		
	Navy-Blue	ACCLOG537	ACCLOG538	ACCLOG539	ACCLOG540	ACCLOG541	ACCLOG542	ACCLOG543	ACCLOG544		
	Pink-Blue	ACCLOG637	ACCLOG638	ACCLOG639	ACCLOG640	ACCLOG641	ACCLOG642	ACCLOG643	ACCLOG644		
<b>P89</b>	<b>SLIP-ON CLOGS</b>	<b>36</b>	<b>37</b>	<b>38</b>	<b>39</b>	<b>40</b>	<b>41</b>	<b>42</b>	<b>43</b>	<b>44</b>	<b>45</b>
	Black	ACCLOG236	ACCLOG237	ACCLOG238	ACCLOG239	ACCLOG240	ACCLOG241	ACCLOG242	ACCLOG243	ACCLOG244	ACCLOG245
<b>P90-91</b>	<b>MAXI Sneakers</b>	<b>36</b>	<b>37</b>	<b>38</b>	<b>39</b>	<b>40</b>	<b>41</b>	<b>42</b>	<b>43</b>	<b>44</b>	<b>45</b>
	Black	ACCSHOE36	ACCSHOE37	ACCSHOE38	ACCSHOE39	ACCSHOE40	ACCSHOE41	ACCSHOE42	ACCSHOE43	ACCSHOE44	ACCSHOE45

## ACCESSORIES

<b>P93</b>	<b>AXIL Leather Knife Roll</b>	<b>7 Pocket</b>											
	Black	AC-AXILROLL01											
	Brown	AC-AXILROLL02											
<b>P93</b>	<b>KNIFE Wrap/Case</b>	<b>7 Pocket</b>			<b>10 Pocket</b>			<b>14 Pocket</b>					
	Black	AC663			AC664			AC665					
<b>P94-95</b>	<b>BOX Hats</b>	<b>Small</b>			<b>Regular</b>			<b>Large</b>					
	White	PROB00			PROB01			PROB02					
	Black	PROB03			PROB04			PROB05					
	Black/White Stripe				AC-528BLK								
	Navy/White Stripe				AC-528NY								
	Navy				AC-530NY								
<b>P94-95</b>	<b>Adjustable CHEF Hat</b>	<b>One Size</b>											
	White	10895											
<b>P94-95</b>	<b>BASEBALL Cap</b>	<b>One Size</b>											
	Black	AC500P											
<b>P94-95</b>	<b>DISPOSABLE Hat</b>	<b>One Size</b>											
	Non-Woven Paper	ACPH10											
<b>P96</b>	<b>APRON Straps</b>	<b>Chocolate</b>			<b>Tan</b>			<b>Grape Fruit</b>			<b>Lemon</b>		
		AC-APRONSTRAP02			AC-APRONSTRAP03			AC-APRONSTRAP04			AC-APRONSTRAP05		
		<b>Lime</b>			<b>Sky</b>			<b>Tangerine</b>					
		AC-APRONSTRAP06			AC-APRONSTRAP07			AC-APRONSTRAP08					
<b>P97</b>	<b>BUTTONS</b>	<b>White</b>			<b>Black</b>								
		AC600			AC601								
<b>P97</b>	<b>NECKERCHIEF</b>	<b>White</b>											
		PRON01											

# About Us

quality | reliability | service | price

## Why Aussie Chef Clothing Company?

Aussie Chef Clothing, established in 1986, is proud to support the hospitality industry and is always focused on providing contemporary, superior quality, modern uniforms, aprons, chef jackets, chef pants, chef shoes and accessories, cleverly designed in hardwearing, durable fabrics and materials that not only look and feel great but also really last.

Aussie Chef Clothing sources only the best fabrics and accessories featuring fade-resistant poly/cotton, natural 100% cotton, durable, comfortable denims, gorgeous leather, matched with high quality accessories, buckles, rivets and embellishments.

Aussie Chef's colour palette is designed to complement your interior design and branding, from simple black and whites to modern neutrals, deep outback hues to ice cream inspired colours and traditional chef stripes.

At Aussie Chef we work with our customers to find the perfect work wear solutions, including embroidery and digital screen printing services. In addition we are able to provide bespoke custom designs based on customer requirements.

Ultimately, we want our customers to look and feel their absolute best during their busy day or night and we are dedicated to making sure each and every garment meets our high standards.



## Our Mission

Aussie Chef is committed to providing our customers and clients with the best work wear across Australia and the world. Products which they can rely on to perform day after day in the rigours of their workplace. This is made possible by having the strictest criteria and quality control processes in place during the design and manufacturing of each and every garment.

All of this is complemented by endeavouring to give our clients a great customer service experience with friendly, expert support staff who are ready to help, excellent stock availability and competitive, importer/factory direct pricing.

Aussie Chef also supports ethical sourcing and is committed to the social, environmental and financial welfare of all workers involved in the manufacturing of our products.



**AUSSIE CHEF**  
CLOTHING COMPANY

114 Murphy Street Richmond VIC 3121 Australia  
t: +613 9427 0033 e: sales@aussiechef.com.au  
w: aussiechef.com.au ABN 22 079 065 331

The information contained in this catalogue was correct at time of publication and any discrepancies are purely coincidental and unintentional.

The images shown herein are representative of the Aussie Chef product range and may differ from the actual garment once purchased.

Products contained in this catalogue are subject to change from time to time. To ensure availability contact our sales department.

No part of this catalogue including images or corporate logos may be reproduced, stored or transmitted without prior written permission of International Trading Agencies P/L and Aussie Chef Clothing Company.

® Aussie Chef Clothing Company is a registered trademark.

© International Trading Agencies P/L & Aussie Chef Clothing Company - March 2026



[aussiechef.com.au](http://aussiechef.com.au)

**AUSSIE CHEF**  
CLOTHING COMPANY